

DECOSAN

# Bath inspirations





Porque la belleza,  
simplemente, es.

DECOSAN

Bath design







Entendemos el baño como el espacio en el que una persona se encuentra a sí misma de una manera introspectiva, natural, sin filtros.

Entendemos el baño como una oportunidad para empezar cada día, de reconocerse y volver a empezar con nuevos retos e ilusiones.

Entendemos el baño con alma, donde el producto tiene vida propia con la armonía perfecta entre belleza y función.

Entendemos el baño como el espacio en el que DECOSAN aporta su esencia para que la vida sea mejor.

DECOSAN

Bath design



<b>00. Bath design</b>	<b>11</b>
Nuestra esencia	12
Materiales con alma	16
Nuestros materiales	18
I + D + I	20
Nuestros conceptos	22
Showroom Profesional	25
Nuestros diseñadores	26

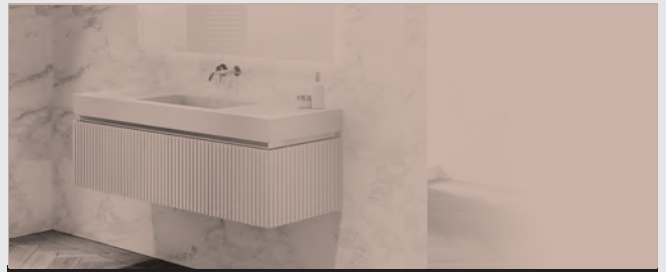

<b>01. Atelier</b>	<b>29</b>
<b>Muebles de baño</b>	
Olympia: Estético.....	30 - Técnico .....104
Diamond: Estético.....	44 - Técnico .....112
Best: Estético.....	62 - Técnico .....122
Queen: Estético.....	80 - Técnico .....132
Alma: Estético.....	88 - Técnico.....140
Complementos Atelier	148



<b>04. Espejos</b>	<b>294</b>
Lisos	300
Retroiluminación trasera	301
Retroiluminación frontal	304
Enmarcados metal	306
Enmarcados madera	308
Armarios espejos	309
Complementa tu espejo	310



<b>05. Iluminación</b>	<b>314</b>
Apliques para espejos	318
Iluminación decorativa	320





<b>02. Casual</b>	<b>155</b>
<b>Muebles de baño</b>	
Play: Estético.....	156 - Técnico .....230
Step: Estético.....	214 - Técnico .....252



<b>03. Encimeras</b>	<b>258</b>
Integradas standard	262
Integradas a medida	268
Lavabo sobre encimera	276
Totems	283
Encimeras planas	284
Complementos de encimera	292



<b>06. Auxiliares</b>	<b>322</b>
Columnas	328
Armarios	330
Estanterías	332
Toalleros	334
Auxiliares Atelier	336

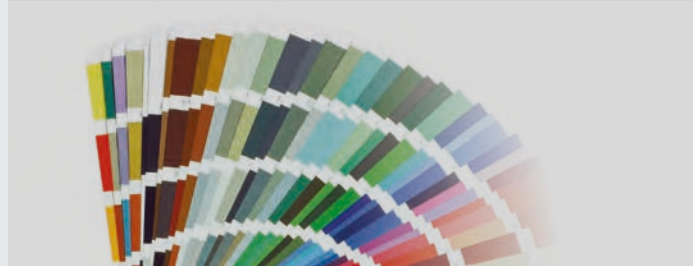

<b>07. Colores</b>	<b>340</b>
Condiciones de venta	348
Manual de instalación	349

La perfección se consigue, no cuando  
no hay nada más que agregar, sino  
cuando ya no hay nada más que quitar.

Antoine de Saint-Exupéry (1900-1944)  
Escritor y poeta francés



# 00 Bath design

DECOSAN

Bath design



## Nuestra esencia

---

Decosan, empresa especialista en la fabricación de mobiliario de baño y complementos, pertenece al grupo empresarial Nofer.

Tras 35 años de experiencia, hoy tenemos un tejido industrial muy potente con una planta de producción de 2200 m<sup>2</sup>, unas oficinas centrales y showroom con 1200 m<sup>2</sup> y un mall logístico con más de 3000 m<sup>2</sup> que nos permiten exportar a más de 70 países.

DECOSAN

Milano

DECOSAN

Moscú



DECOSAN

Barcelona

DECOSAN

Dubai

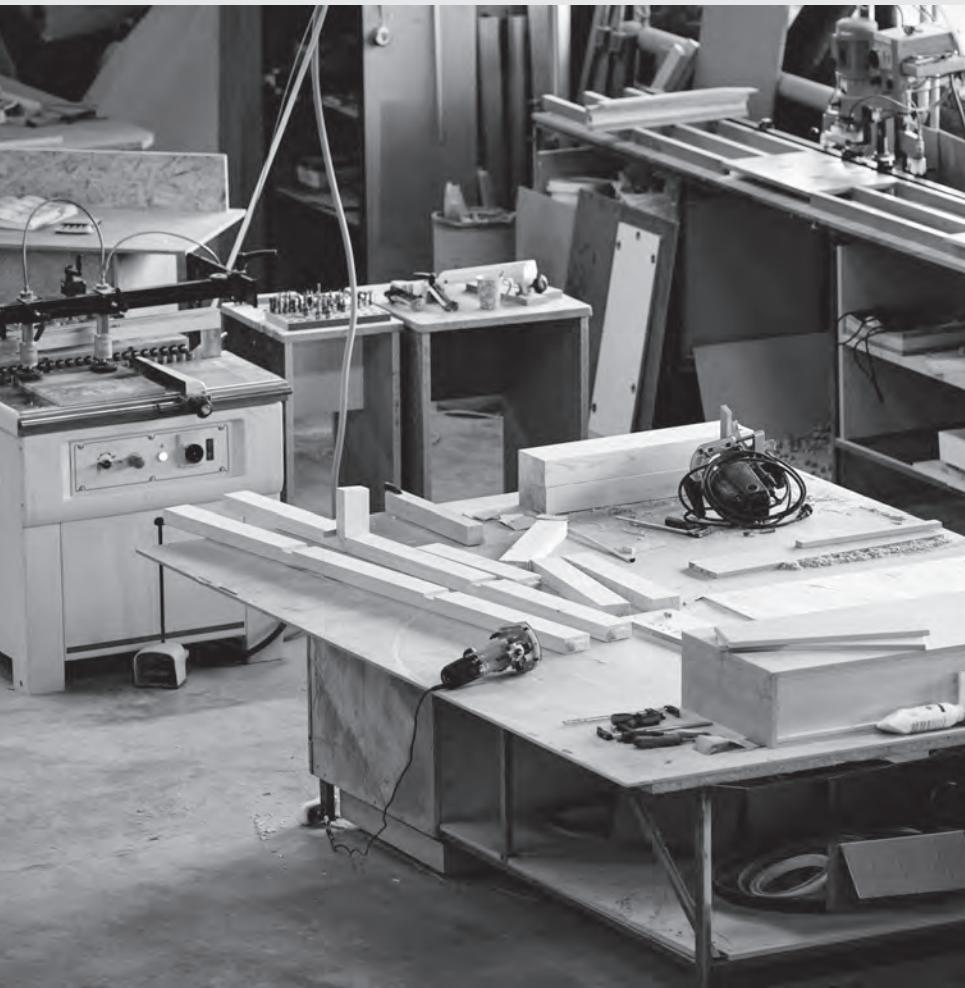

Una industria 100% Made in Barcelona donde artesanía y tecnología se fusionan para crear soluciones únicas con un especial cuidado por el detalle.









## Materiales con alma

---

Como fabricantes, seleccionamos con mimo la materia prima con la que trabajar, aportando nuestro know-how artesanal, al que unimos la máxima tecnología industrial que disponemos en nuestra planta de producción de Barcelona.

Respetar el producto y tratarlo bien nos permite mantener la esencia de cada materia prima en nuestro producto final.



# Nuestros materiales



## Madera Nature

Acabado decorativo que se aplica en tableros de madera de partículas y que presenta múltiples colores y acabados, con muy buenas prestaciones mecánicas y resistente a los arañazos, golpes y abrasión.

## Solid Surface (Cristalplant)

Solid Surface es un material de última generación compuesto por dos terceras partes de minerales naturales y resinas BIObased derivadas del maíz. El resultado es un material no poroso, antibacteriano, sedoso y cálido al tacto. Su estructura y la composición le confiere la característica de reparable.

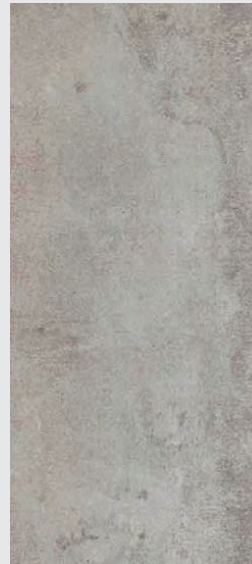
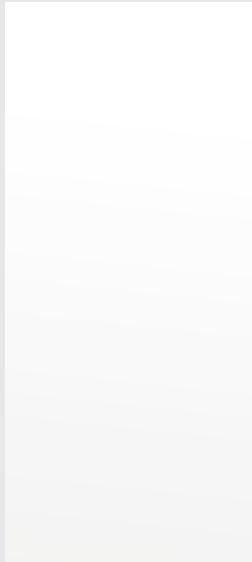

## Microcemento

Material decorativo compuesto a base de cemento y pigmentos minerales para conseguir un acabado compacto, muy resistente y de fácil limpieza.

## Madera Maciza

Madera de roble natural 100%. El tablero de roble macizo se fabrica alistonado, es decir, pegando listones entre sí de entre 8 a 15 cm. Producto natural de extraordinaria belleza que respeta las irregularidades del tronco del árbol y que está protegido con aceites naturales que le aportan gran durabilidad manteniendo su aspecto natural.

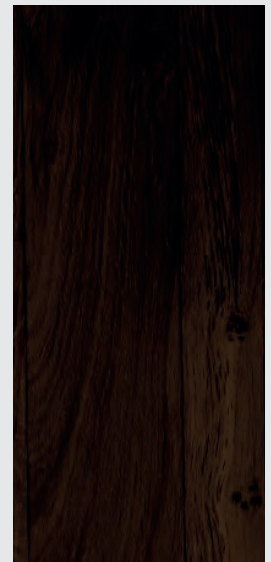

## Fibrilac

Material que por su composición y características de alta densidad es ideal para conseguir acabados lacados mate y de alto brillo. Está fabricado a partir de fibras de madera prensadas en seco con resinas sintéticas que actúan como ligante ofreciendo una estructura compacta y muy lisa.

## Madera Tablero Marino

Tablero marino multicapa de colas fenólicas de gran estabilidad dimensional y resistencia a la humedad. A este material se le aplacan chapas naturales de roble, roble rústico o nogal según sea el acabado deseado. El acabado final se consigue con aceites naturales respetando la textura con máxima protección a los agentes externos.

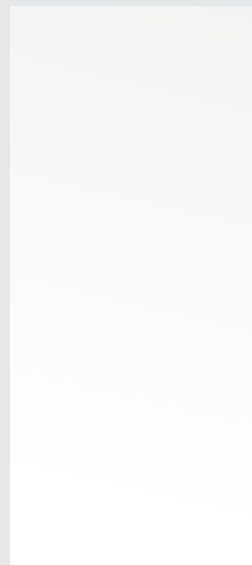

## Solid Mineral

Material compuesto por cargas minerales naturales y resinas de alta resistencia. Se trata de un material no poroso, antibacteriano, ligero y de tacto muy sedoso.



### Piedra Natural

Roca calcárea cristalizada y compacta 100% natural extraída de las canteras. Se dispone de una amplia gama de colores con un tratamiento antimanchas de acabado mate que evita la absorción. Es un producto natural e irrepetible por lo que las muestras de color son únicamente orientativas.

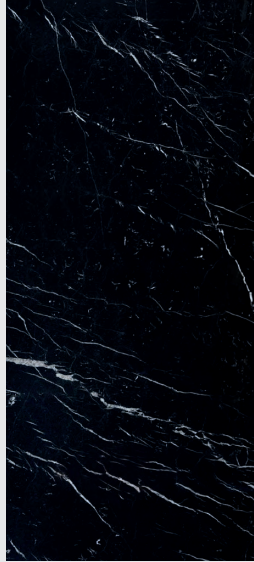

### Cerámica

Pasta de sustancias arcillosas de estructura compacta, moldeada y sometida a diferentes procesos de cocción que garantizan la vitrificación de la superficie, lo que le aportan extraordinarias prestaciones mecánicas, higiénicas y de muy fácil mantenimiento.

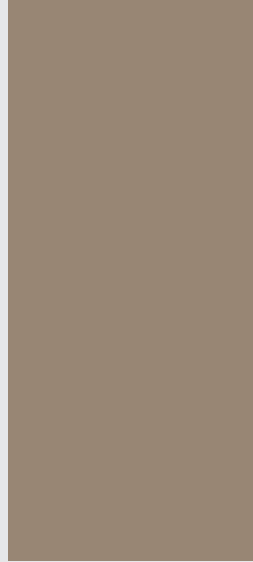

### Resina

Novedoso material sintético de gran calidad y planimetría. Su color blanco cerámico lo hace idóneo para las nuevas líneas de mobiliario de baño. Su tacto es cálido, es de fácil limpieza y posee una larga duración además de ser resistente a la degradación.

### Ceramcolor

Esmalte coloreado de alto rendimiento a base de nano partículas con altas propiedades antibacterianas, no poroso y con grandes resistencias mecánicas a las manchas y agentes químicos. Es de aplicación sobre porcelana y piedra compacta,

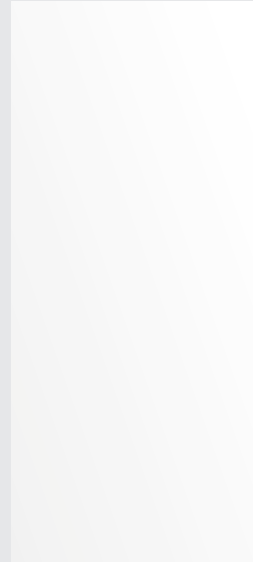

### Glass Blanco

Cristal coloreado en masa de color blanco generando un cristal blanco opaco con acabado brillante.



### Cristalcolor

Cristal óptico totalmente transparente que se colorea y vitrifica en el horno. Los lavabos termoformados se consiguen en hornos a altas temperaturas consiguiendo un lavabo con una caída progresiva y una textura mate y sedosa al tacto.



### Metal Inox

El acero inoxidable es un acero de alta aleación que contiene cromo y otros aglomerantes que le aportan una característica de gran resistencia a la corrosión. Los productos en acero inoxidable son sometidos a tratamientos superficiales de pulido o satinado pero también pueden recibir baños de color para conseguir otros acabados.



Nuestros materiales

# I+D+I

## Investigación, Desarrollo e Innovación

---

El tratamiento de los materiales y la máxima implicación en el desarrollo de nuevos productos y sistemas nos permiten ofrecer propuestas innovadoras con identidad propia.

Nuestro compromiso en la mejora continua nos ha permitido implementar nuevos sistemas y tecnologías que mejoran la calidad de uso y confort de cada producto.





# Nuestros conceptos



## A MEDIDA

Esta colección permite su fabricación a medida. En el caso de medidas intermedias de altura y anchura tomar el precio de la medida inmediatamente superior.



## ANTRACITA FULLCOLOR

Concepto de diseño interior por el que todos los materiales del interior de los muebles están diseñados en color antracita. Los muebles con acabado lacado se lacan interiormente en color antracita.



## ATELIER SYSTEM

En los acabados de tablero marino o madera maciza se seleccionan las piezas de forma numerada para respetar la continuidad de la veta en todo el mueble.

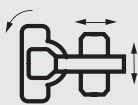

## BLUM 3D BISAGRAS

Las bisagras tienen regulación de altura, profundidad e inclinación para un ajuste perfecto.



## CAJONES 4D

Cajones metálicos Hettich o Blum de color antracita y de perfil extrafino de 12 mm con 4 regulaciones de ajuste. Las guías son de extracción total y sistema de frenado progresivo.



## DECOBUILD SYSTEM

Los muebles fabricados con tableros de 19 mm están encolados entre sí con clavillas consiguiendo una estética limpia sin herrajes visibles y ofreciendo mejor resistencia y durabilidad.



## DECOFIX SYSTEM

Sistema de fijación a pared de alta seguridad con el que las resistencias de carga son superiores a 240 kg.



## DECOSPACE SYSTEM

Sistema que incluye el suministro de un sifón ahorra espacio y una válvula clic clac cromo brillo. Con esta solución se evita el cajeado del cajón superior mejorando la capacidad de almacenamiento y estética interior ya que las instalaciones quedan ocultas.



## DURALACK SYSTEM

Los acabados en laca llevan unos aditivos endurecedores que permiten que el acabado final sea muy resistente al frote y a la abrasión.



## ESTANTES INTERIORES CRISTAL

Los estantes interiores de cristal son de 6 mm de espesor. En el caso de columnas y armarios de vitrina los estantes son de color gris fumé.

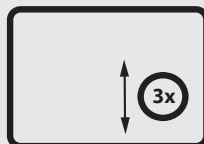

## ESPEJO AUMENTO MÓVIL

Puedes equipar el espejo con un espejo de aumento x3 imantado que te permite colocarlo en la zona habilitada del espejo y regular su posición.

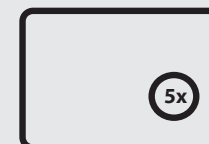

## ESPEJO AUMENTO

Puedes personalizar tu espejo con un espejo de aumento x5 integrado con iluminación LED perimetral.



#### ESPEJOS CON ANTIVAHO

Puedes equipar el espejo con sistema antivaho. Una lámina térmica adherida a la parte trasera del espejo evitará la condensación del agua sobre el espejo mejorando el confort de uso y la perfecta reflexión del espejo.



#### ESPEJOS CON BLUETOOTH

Puedes vincular tu móvil al espejo por bluetooth y disfrutar tu música en el baño.



#### ESPEJOS CON LUZ FRÍA Y/O CÁLIDA

Puedes personalizar tu espejo con la temperatura de color que desees, más cálida o más fría, de 2700°K a 5500°K. Incluso puedes equipar tu espejo con un sensor táctil que te permitirá el cambio de temperatura de color, ya sea, cálida, neutra o fría.



#### ESPEJOS CON SENSOR ENCENDIDO ON/OFF

Esta opción te permitirá encender/apagar el espejo y cambiar la intensidad lumínica si así lo necesitas con una ligera presión sobre el sensor táctil.



#### PUSH AND SLOW

Los cajones con sistema de apertura Push sin tirador llevan un sistema de sincronización que permite su apertura haciendo presión en cualquier punto del frontal. A su vez el cierre es progresivo y silencioso.



#### PUSH PUERTAS SIN TIRADOR

Las puertas de las columnas y armarios tienen el sistema de expulsión push que se puede utilizar también con función únicamente de retenedor.



#### SENSOR ANTIVAHO

Sensor ON/OFF para lámina antivaho.



#### SISTEMA COLGAR SEGURIDAD ANTIDESCUELGUE 150 KG

Las columnas y armarios llevan un sistema de colgar antidescuelgue de seguridad con una capacidad de carga de 150 kg.



#### SISTEMA SCREEN CON SENSOR ENCENDIDO ON/OFF

La tecnología nos permite replicar la pantalla de tu móvil en el espejo. Con ello, podrás reproducir en el espejo de una manera fácil todos los contenidos de tu móvil como videos y fotos. Compatible con IOS y Android.



#### WOOD PROTECT SYSTEM

Las maderas tablero marino o madera maciza están protegidas contra los agentes externos con aceites naturales que respetan la textura y naturaleza de la madera.



Nuestros conceptos



Made in Barcelona

Un espacio para compartir  
experiencias ubicado en el  
corazón de Barcelona, ciudad de  
diseño y de inspiración.





## Showroom Profesional

---

Workshops, mesas redondas, seminarios y diferentes actividades para estar cerca del profesional con el que construir el futuro del diseño e interiorismo del baño.



Inspírate. Déjanos llevarte a un espacio con alma, imagina el baño de tus sueños, te invitamos a que lo toques, lo sientas y lo hagas tuyo.

# Nuestros diseñadores

---

Los diseñadores trabajan según un proceso de diseño que comienza con la interpretación o detección de un problema o necesidad y culminan con la producción o construcción de la solución a este problema.



## *CirculoCuadrado*

CirculoCuadrado es el estudio de interiorismo formado por Ismael Barajas y Maribel Caballero, titulados en Diseño de Interiores en Barcelona.

Tras una larga trayectoria individual, inauguran su estudio en común en el año 2006. Se definen de estilo con influencia minimalista, en constante búsqueda del orden visual y de la aplicación de materiales nobles.

CIRCULO<sup>®</sup>  
CUADRADO

## *Decosan Studio*

Nuestro equipo desarrolla diseños y conceptos con una visión global. Materiales, tecnología, forma, ergonomía, lenguaje, comunicación visual y creatividad son elementos que consideramos en todos los proyectos para conseguir el producto ideal.





# 01 Atelier Muebles de baño

Cuidado por el detalle, artesanía  
en forma de estilo.

# Olympia

El estilo que nunca  
ha dejado de ser.

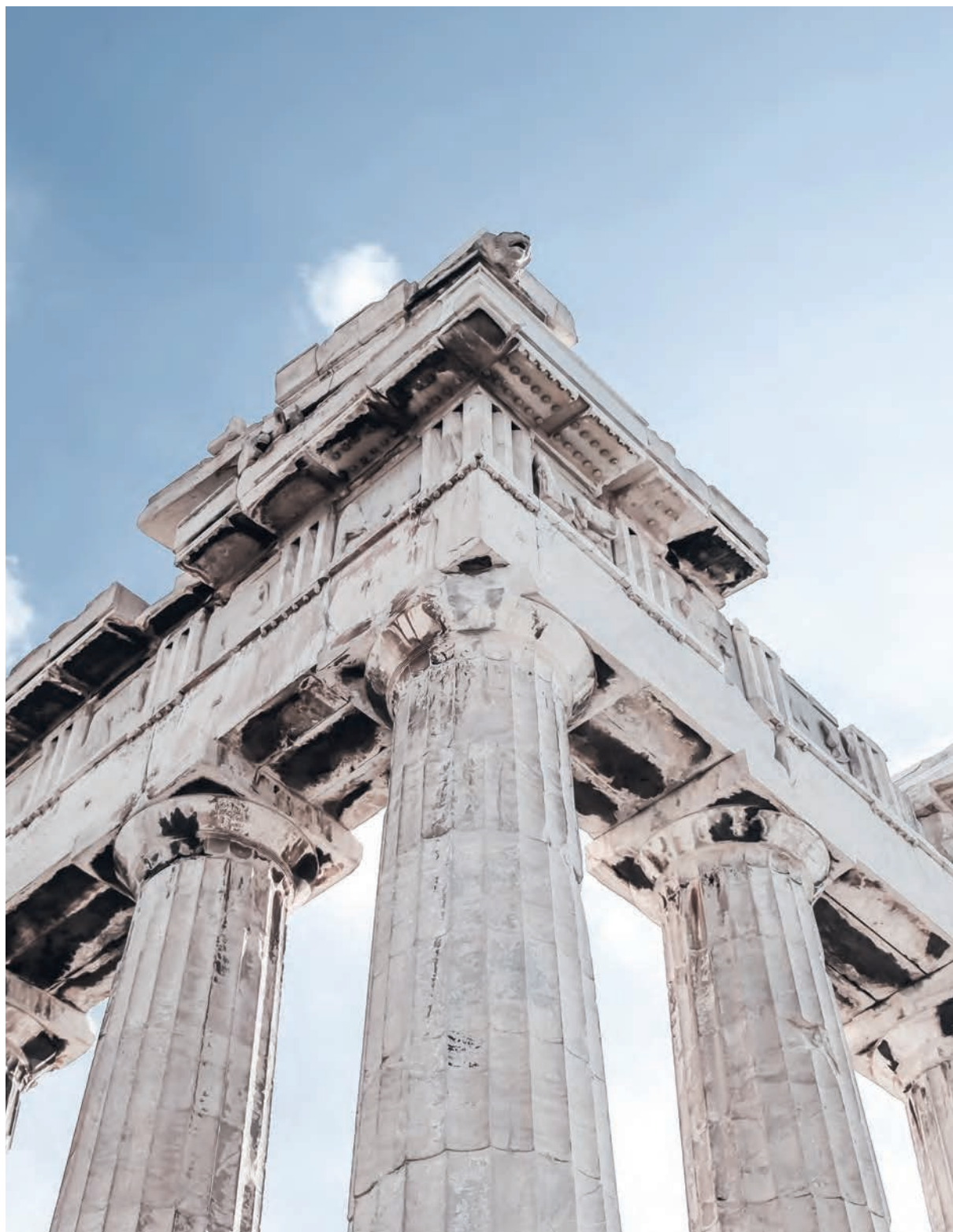



▲ Bañera  
*Orion Solid Surface*



Luz decorativa  
*Ledpoint*



Auxiliar  
*Toallero a pared*







Mueble  
1 cajón / acabado friso lacado / cuello acero cepillado



Espejo retroiluminado  
Spined





▲ Mueble suspendido de altura 35 cm



Beige



Perla



Acero



Piedra



Tierra



Caqui



Albero



Moka



Antracita

- ▲ Personaliza el color de tu mueble con 18 colores standard o de la carta RAL o NCS





▼ Encimera con lavabo integrado Plus en Piedra Natural Negro Marquina



▼ Mueble de altura 54 cm con  
baúl y cajón interior



▼ Estructura de mueble ingletada  
en Madera de Tablero Marino



▲ Sistema Decospace. Cajón superior  
sin recorte. Válvula y sifón  
ahorraespacio incluido

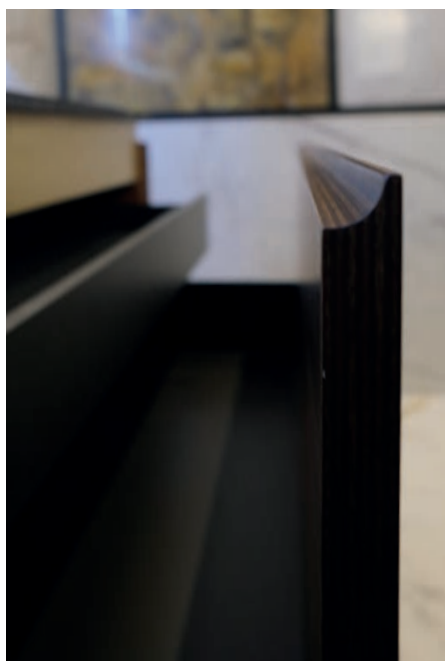

▲ Cajones extrafino 4D con  
sistema de extracción total y  
frenado silencioso



▲ Auxiliar  
Columna puerta cristal fumé y perfil  
vitrina metálica negro mate





Mueble  
1 cajón / acabado liso  
roble rústico / cuello lacado  
Negro Mate



108

Encimera  
Encimera Madera Tablero Marino de roble  
acabado Legno Rústico  
Lavabo sobreencimera inox



286

OLYMPIA

Espejo retroiluminado  
Circled



301



◀ Personaliza tu mueble Olympia con textura friso o lisa



OLYMPIA

▼ Textura friso



▲ Textura lisa

Personaliza el cuello del mueble con acabados metálicos, lacados en cualquier color o madera natural en ocho colores diferentes



# Diamond

La talla del diamante  
lo convierte en joya.

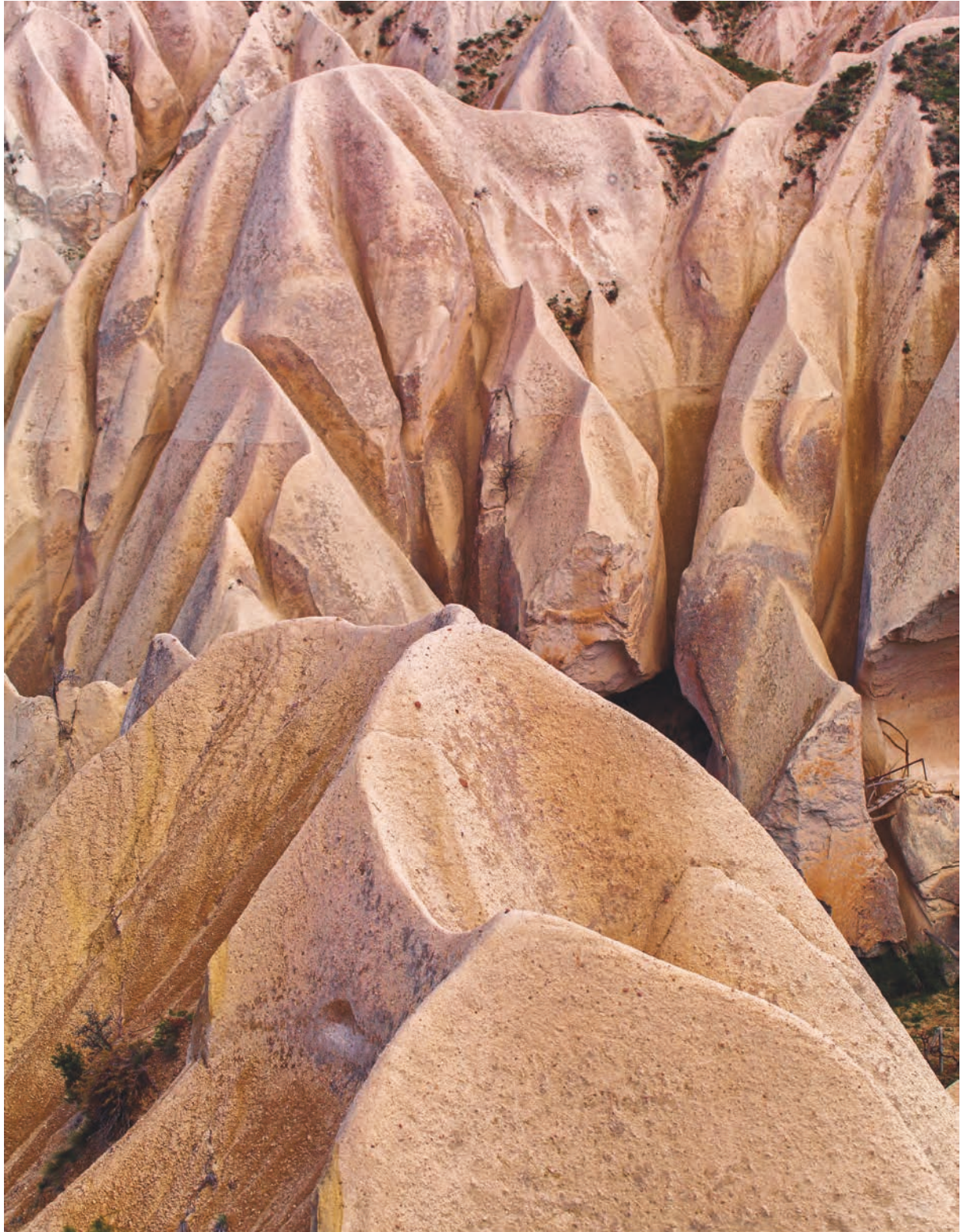



116

Mueble ▶

Composición de 3 cajones y 2 huecos  
decorativos / acabado Nogal y Negro  
Mate / tirador Inglete Diamond



274

Encimera integrada  
Cristalcolor Negro



338

Bañera  
Andrómeda Solid Surface



320

Luz decorativa  
Ledarc











- ◀ Espejo retroiluminado  
*Spinled con espejo de aumento móvil*

Auxiliar  
*Estante decorativo box con separador interior móvil*

Luz decorativa  
*Ledarc negro mate*

- ▼ Atelier design  
*Veta continua de la madera en toda  
la longitud del mueble*





119

Mueble ▶

*2 baúles / acabado lacado /  
tirador Push*



274

Encimera

*Integrada Cristalcolor acabado mate*



303

Espejo retroiluminado

*Spinled*



320

Luz decorativa

*Ledarc*







- ▲ Encimera integrada en cristal óptico con textura mate y personalizable con cualquier color de la carta RAL

▼ Laterales con inglete  
efecto diamante



▼ Detalle efecto diamante exterior  
con bisel perimetral

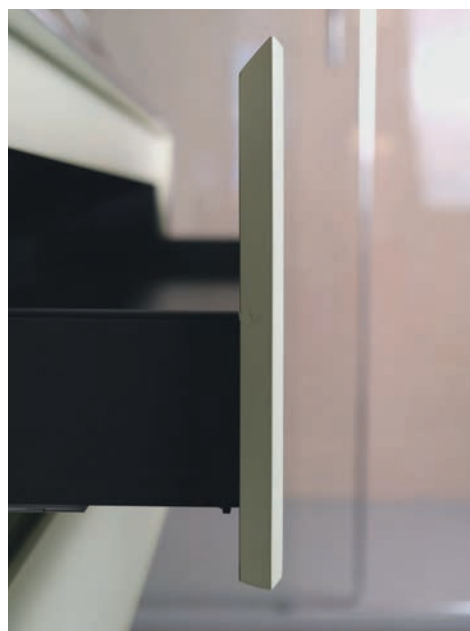
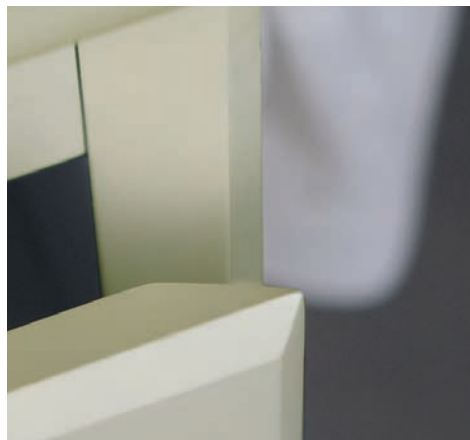

▲ Detalle efecto diamante interior  
con inglete



### Mueble

2 cajones / acabado madera tablero marino /  
tirador Diamond



### Encimera

Encimera plana Solid Surface



Lavabo sobreencimera Solid Surface Prim





302

### Espejo

*Espejo Retroled  
Espejo aumento móvil*



321

### Luz decorativa

*Ledcirc*



339

### Bañera

*Orion Solid Surface*



328

### Auxiliar

*Columna de doble puerta de  
Madera Tablero Marino*





◀ Veta continua, respetando la malla de la madera

Detalle del tirador Diamond. ▶  
Doble bisel interior y exterior  
reproduciendo la talla  
de un diamante







- ▲ **Mueble**  
*Composición decorativa en ángulo con encimera de Piedra Natural y módulo de 1 cajón con encimera lacada*



- Espejos enmarcados**  
*Metal color negro*





Espejo  
*Camerino 2 puertas*



Luz decorativa  
*Ledcirc*





◀ Armario espejo con puertas asimétricas con laterales de espejo y tirador oculto



◀ Módulo complemento con encimera lacada



▲ Encimera  
mural con lavabo integrado  
de Piedra Natural

Espejos  
Espejo Metalround y  
Metalroundled

Luz decorativa  
Ledcirc



DIAMOND

# Best

Arquitectura pura,  
fusión de elementos.











- ◀ Personalización led.  
Espejo Roundled con led  
perimetral personalizable en  
su temperatura de color

- ◀ Integración del color.  
Lavabo cerámico de color.  
Encimera Ceramcolor.  
Mueble lacado.  
Diferentes elementos y  
materiales con el mismo color

▼ Tirador y estructura inglete a 45°



Auxiliares ▶

*Composición columnas  
decorativas con puerta  
de madera y tirador push.  
Estante Twin en acabado  
roble Legno Rústico*





▲ Mueble  
2 baúles y 1 cajón interior / tirador  
Push / roble acabado Legno Rústico

Encimera integrada  
Solid Mineral

Espejo con iluminación frontal  
Duoled

Luz decorativa  
Ledcirc



▲ Encimera integrada lavabo Regata en acabado Pizarra natural

Estantería metálica con doble estante de Madera Tablero Marino en roble Legno Rústico ▶



▼ Detalle de tirador y estructura inglete a 45°



▼ Cajones metálicos 4D con extracción total y cierre silencioso



Detalle de tirador Inglete ▶





127

Mueble ▶

*2 cajones / tirador  
Inglete / acabado lacado*



291

Encimera

*Plana Piedra Natural/  
Lavabo sobreencimera  
Piedra Natural*



306

Espejo iluminación  
frontal

*Metalrounded*



321

Luz decorativa

*Ledcirc*

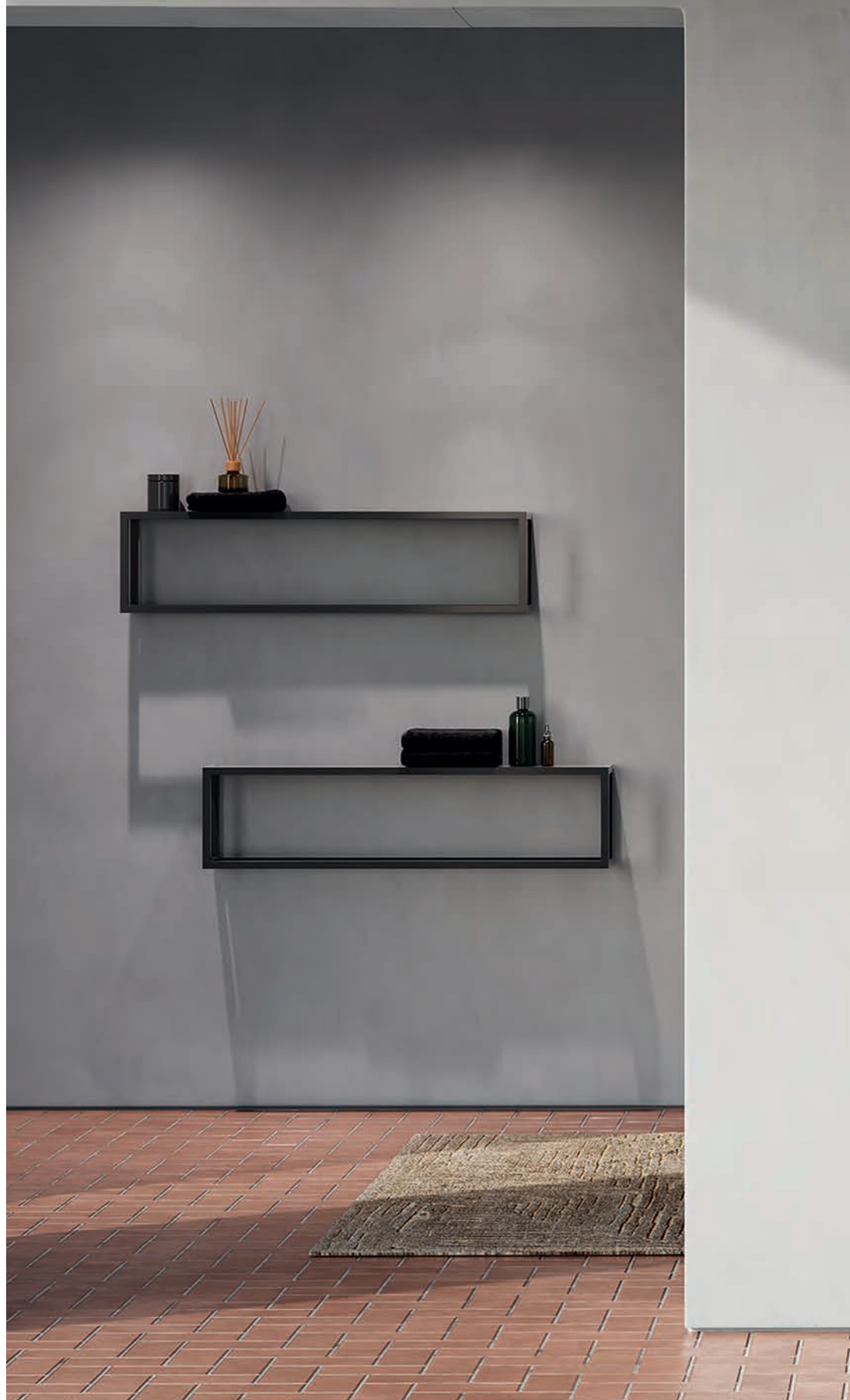







▲ Materiales y colores.  
Equilibrio estético



◀ Luz decorativa  
*Ledpoint*



◀ Auxiliar  
*Estantería metálica con  
doble estante lacado*



▲ Mueble  
*Bancada auxiliar con encimera  
Solid Mineral*



130

Espejo  
*Corner*



308

Auxiliar  
*Estantería decorativa Box*



333



Mueble  
1 baúl + 2 cajones / tirador  
Push / acabado Madera  
Tablero Marino



Encimera  
Plana Solid Mineral.  
Lavabo ángulo Solid Mineral modelo Hug  
con estantería decorativa lateral



Espejo  
Triled con sistema Screen



▼ Especialistas en Solid Surface. Bañeras, encimeras, lavabos



▲ Arquitectura con Solid Surface. Proyectos a medida



BEST



# Queen

Estilo único, distinguido.





308

Espejo enmarcado  
*Luxor plata*

291

Encimera plana  
*Piedra Natural Carrara*

136

Mueble  
*1 cajón / tirador Queen /  
acabado lacado*





137

### Mueble

4 cajones / tirador Queen /  
acabado lacado



272

### Encimera integrada

Piedra Natural Carrara  
con doble lavabo



308

### Espejo enmarcado

Luxor plata





◀ Mueble  
1 cajón / tirador Queen /  
acabado lacado

Espejo enmarcado  
Luxor oro

Detalle  
Tirador y aristas oro



Detalle  
Tirador y aristas cromo





◀ Mueble  
*Laca Blanco*



◀ Mueble  
*Laca Océano*



◀ Mueble  
*Laca Negro*



◀ Mueble  
*Laca Burdeos*

Mueble ▶  
*4 cajones / tirador Queen /  
acabado lacado*

Espejo enmarcado  
*Luxor oro*



QUEEN



# Alma by

La esencia de la materia  
prima. Respetar y mimar  
el producto.









◀ Mueble

*Bancada 2 cajones / tirador Push / acabado roble macizo en frontal y lacado en los laterales*

 146

Encimera

*Plana mural en roble macizo*

 287

Espejo

*Round Liso de estructura metálica*

 300

Bañera

*Leo Solid Surface*

 338



▲ Auxiliar

*Toallero Lean en roble macizo*

 337

Lavabo ▶  
Solid Surface  
Elíptico, extrafino



Encimera mural ▶  
ingletada en roble  
macizo





- ▲ Encimera suspendida mural de roble macizo a medida



▲ Auxiliares

*Banqueta estructura metálica con sobre de roble macizo*



335



Lavabo  
*Tótem Solid Surface*



Encimera  
*Plana Solid Surface  
blanco mate*



Mueble  
*2 cajones / tirador Push / lateral fino  
Blanco mate y frontal roble macizo  
en acabado Legno*



Luz decorativa  
*Ledcirc*





▲ Tótem de Solid Surface





▲ Detalle del lateral extrafino lacado

## CIRCULO CUADRADO



145

### Mueble ▶

*2 cajones / tirador Push /  
acabado lacado*



270

Encimera integrada  
*Solid Surface*



287

Encimera plana  
*Encimera acabado lacado*



300

Espejo liso  
*A medida*



321

Luz decorativa  
*Juego Ledcirc*



336

Auxiliares  
*Columnas by CirculoCuadrado  
acabado lacado*











CIRCULO  
CUADRADO

◀ Auxiliares  
Set de tocadores by  
CirculoCuadrado  
acabado lacado

Auxiliares ▶  
Columnas by  
CirculoCuadrado  
acabado lacado



	NCSS 7500-N
	NCSS 1002-Y
	NCSS 5010-G70Y
	NCSS 5010-B10G
	NCSS 4030-Y80R
	NCSS 4010-Y90R

▲ Colores  
Colores sugeridos  
por CirculoCuadrado  
acabado lacado,  
mate o brillo



ALMA



# 01

## Información técnica y tarifa

# Atelier

DECOSAN

Bath design





# Olympia

Características y equipamiento	106
Personaliza tu mueble Olympia	107
Bases de lavabo suspendidas	108
Módulos suspendidos	110
Complementos Atelier	148



#### DECOSPACE SYSTEM

Sistema que incluye el suministro de un sifón ahorra espacio y una válvula clic clac cromo brillo. Con esta solución se evita el cajeado del cajón superior mejorando la capacidad de almacenamiento y estética interior ya que las instalaciones quedan ocultas.



#### CAJONES 4D

Cajones metálicos Hettich o Blum de color antracita y de perfil extrafino de 12 mm con 4 regulaciones de ajuste. Las guías son de extracción total y sistema de frenado progresivo.



#### A MEDIDA

Esta colección permite su fabricación a medida. En el caso de medidas intermedias de altura y anchura tomar el precio de la medida inmediatamente superior.



#### ANTRACITA FULLCOLOR

Concepto de diseño interior por el que todos los materiales del interior de los muebles están diseñados en color antracita. Los muebles con acabado lacado se lacan interiormente en color antracita.



#### DURALACK SYSTEM

Los colores lacados llevan unos aditivos endurecedores que permiten que el acabado final sea muy resistente al frote y a la abrasión.



#### DECOFIX SYSTEM

Sistema de fijación a pared de alta seguridad con el que las resistencias de carga son superiores a 240 kg.



#### DECOBUILD SYSTEM

Los muebles fabricados con tableros de 19 mm están encolados entre sí con clavillas consiguiendo una estética limpia sin herrajes visibles y ofreciendo mejor resistencia y durabilidad.



#### WOOD PROTECT SYSTEM

Las maderas tablero marino están protegidas contra los agentes externos con aceites naturales que respetan la textura y naturaleza de la madera.



#### ATELIER SYSTEM

En los acabados de tablero marino se seleccionan las piezas de forma numerada para respetar la continuidad de la veta en todo el mueble.

# Configura y personaliza tu mueble Olympia

## A Escoge la textura

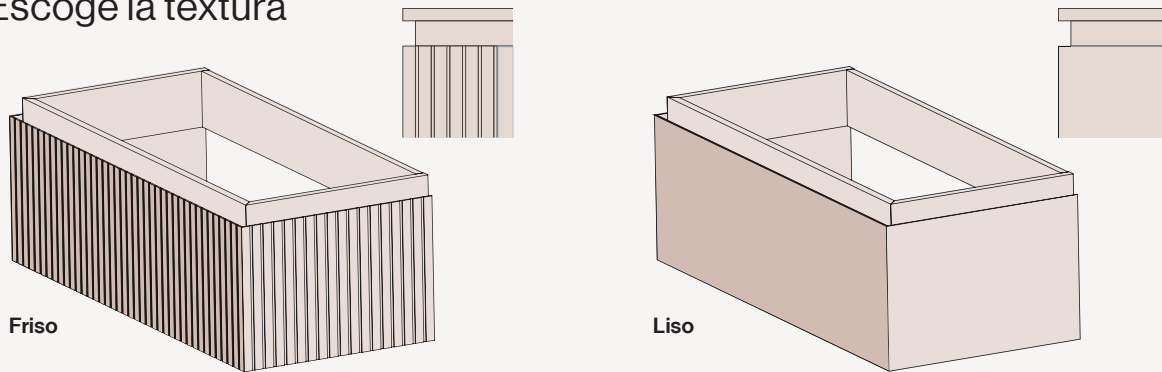

## B Escoge el color del mueble

### Lacados

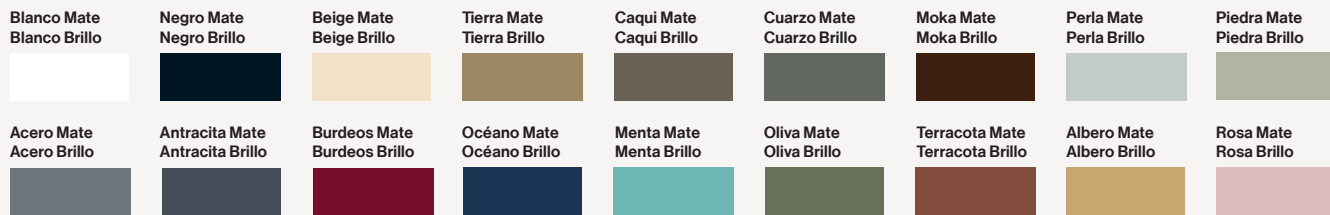

### Madera Tablero Marino / Chapa de Roble y Nogal

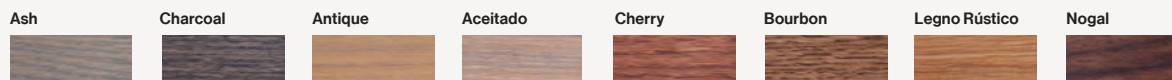

## C Escoge el color del cuello

### Lacados



### Madera Tablero Marino / Chapa de Roble y Nogal

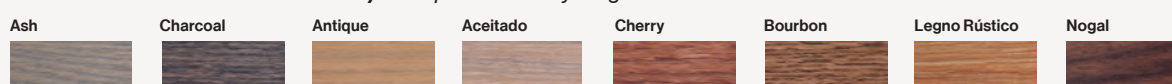

### Metal



### BASES DE LAVABO SUSPENDIDAS

#### 1 CAJÓN

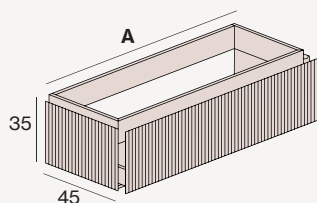

A (cm)	LAVABO	REF	LACA		MADERA TABLERO MARINO	
			FRONTAL FRISO	FRONTAL LISO	FRONTAL FRISO	FRONTAL LISO
60		Y101.060.C	-	-	-	-
70		Y101.070.C	-	-	-	-
80		Y101.080.C	-	-	-	-
90		Y101.090.C	-	-	-	-
100		Y101.100.I	-	-	-	-
100		Y101.100.C	-	-	-	-
100		Y101.100.D	-	-	-	-
120		Y101.120.I	-	-	-	-
120		Y101.120.C	-	-	-	-
120		Y101.120.D	-	-	-	-
120		Y101.120.X	-	-	-	-
140		Y101.140.I	-	-	-	-
140		Y101.140.C	-	-	-	-
140		Y101.140.D	-	-	-	-
140		Y101.140.X	-	-	-	-

#### 2 CAJONES ASIMÉTRICOS

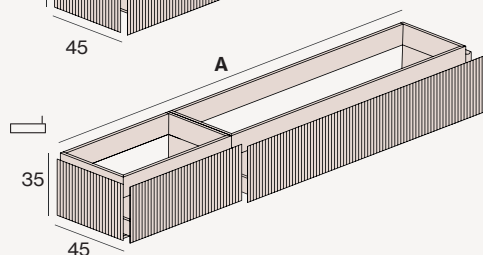
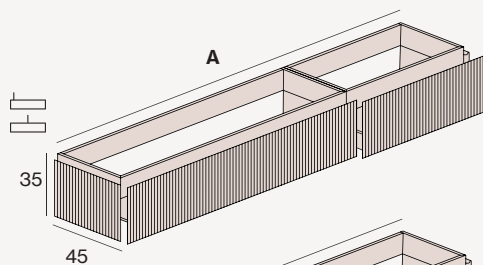

120		Y102.120.I	-	-	-	-
120		Y102.120.C	-	-	-	-
120		Y102.120.D	-	-	-	-
140		Y102.140.I	-	-	-	-
140		Y102.140.C	-	-	-	-
140		Y102.140.D	-	-	-	-
160		Y102.160.I	-	-	-	-
160		Y102.160.C	-	-	-	-
160		Y102.160.D	-	-	-	-
180		Y102.180.I	-	-	-	-
180		Y102.180.C	-	-	-	-
180		Y102.180.D	-	-	-	-
200		Y102.200.I	-	-	-	-
200		Y102.200.C	-	-	-	-
200		Y102.200.D	-	-	-	-

#### 2 CAJONES SIMÉTRICOS

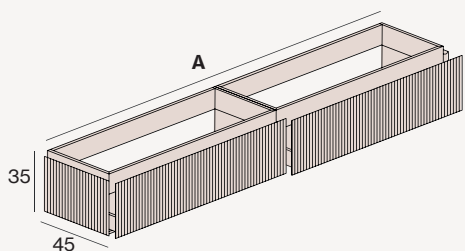

120		Y103.120.I	-	-	-	-
120		Y103.120.D	-	-	-	-
120		Y103.120.X	-	-	-	-
140		Y103.140.I	-	-	-	-
140		Y103.140.D	-	-	-	-
140		Y103.140.X	-	-	-	-
160		Y103.160.I	-	-	-	-
160		Y103.160.D	-	-	-	-
160		Y103.160.X	-	-	-	-
180		Y103.180.I	-	-	-	-
180		Y103.180.D	-	-	-	-
180		Y103.180.X	-	-	-	-
200		Y103.200.I	-	-	-	-
200		Y103.200.D	-	-	-	-
200		Y103.200.X	-	-	-	-



· Las composiciones asimétricas tienen la siguiente modulación: 120 (80+40), 140 (100+40), 160 (100+60), 180 (120+60), 200 (120+80). Otras configuraciones disponibles.

· Muebles especiales: Para medidas intermedias en anchura y/o altura tomar el precio de la medida inmediatamente superior. Fondo especial disponible de 39 a 45cm. Otros fondos consultar.

· El mueble de altura 35 no lleva sistema Decospace. Si la instalación lo permite se puede pedir sin sobreprecio.

C Lavabo centrado

D Lavabo derecho

I Lavabo izquierdo

X Lavabo doble

### BASES DE LAVABO SUSPENDIDAS

#### BAÚL

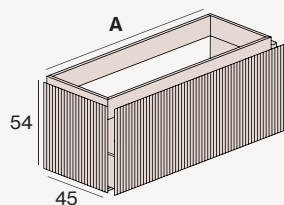

(1)

A (cm)	LAVABO	REF	LACA		MADERA TABLERO MARINO	
			FRONTAL FRISO	FRONTAL LISO	FRONTAL FRISO	FRONTAL LISO
60		Y202.060.C	-	-	-	-
70		Y202.070.C	-	-	-	-
80		Y202.080.C	-	-	-	-
90		Y202.090.C	-	-	-	-
100		Y202.100.I	-	-	-	-
100		Y202.100.C	-	-	-	-
100		Y202.100.D	-	-	-	-
120		Y202.120.I	-	-	-	-
120		Y202.120.C	-	-	-	-
120		Y202.120.D	-	-	-	-
120		Y202.120.X	-	-	-	-
140		Y202.140.I	-	-	-	-
140		Y202.140.C	-	-	-	-
140		Y202.140.D	-	-	-	-
140		Y202.140.X	-	-	-	-

#### 2 BAÚLES ASIMÉTRICOS

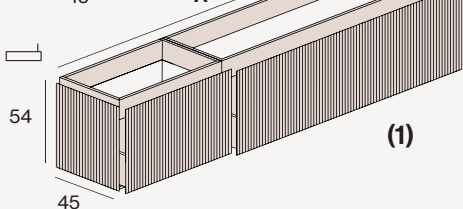
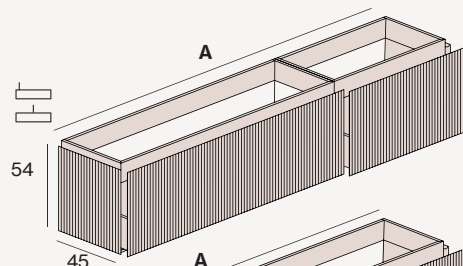

(1)

120		Y210.120.I	-	-	-	-
120		Y210.120.C	-	-	-	-
120		Y210.120.D	-	-	-	-
140		Y210.140.I	-	-	-	-
140		Y210.140.C	-	-	-	-
140		Y210.140.D	-	-	-	-
160		Y210.160.I	-	-	-	-
160		Y210.160.C	-	-	-	-
160		Y210.160.D	-	-	-	-
180		Y210.180.I	-	-	-	-
180		Y210.180.C	-	-	-	-
180		Y210.180.D	-	-	-	-
200		Y210.200.I	-	-	-	-
200		Y210.200.C	-	-	-	-
200		Y210.200.D	-	-	-	-

#### 2 BAÚLES SIMÉTRICOS

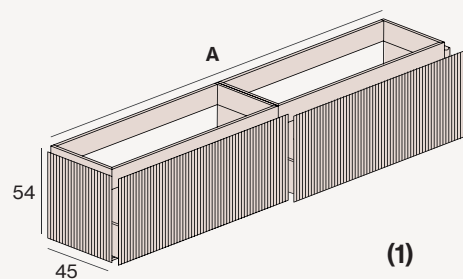

(1)

120		Y211.120.I	-	-	-	-
120		Y211.120.D	-	-	-	-
120		Y211.120.X	-	-	-	-
140		Y211.140.I	-	-	-	-
140		Y211.140.D	-	-	-	-
140		Y211.140.X	-	-	-	-
160		Y211.160.I	-	-	-	-
160		Y211.160.D	-	-	-	-
160		Y211.160.X	-	-	-	-
180		Y211.180.I	-	-	-	-
180		Y211.180.D	-	-	-	-
180		Y211.180.X	-	-	-	-
200		Y211.200.I	-	-	-	-
200		Y211.200.D	-	-	-	-
200		Y211.200.X	-	-	-	-

#### Complementos

##### & complementa

COMPLEMENTA  
TU MUEBLE  
Organizadores, toalleros,...  
pág. 148

##### (1) CAJÓN INTERIOR

El cajón interior se puede poner en las composiciones con baúl.

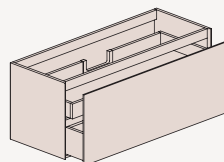

A (cm)	REF	PVP
40	A220.040	-
60	A220.060	-
70	A220.070	-
80	A220.080	-
90	A220.090	-
100	A220.100	-
120	A220.120	-
120X	A220.120X	-
140	A220.140	-
140X	A220.140X	-

### MÓDULOS SUSPENDIDOS

#### 1 CAJÓN / BANCADA

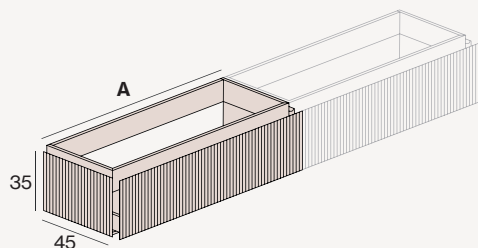

A (cm)	REF	LACA		MADERA TABLERO MARINO	
		FRONTAL FRISO	FRONTAL LISO	FRONTAL FRISO	FRONTAL LISO
30	Y101.030.M	-	-	-	-
40	Y101.040.M	-	-	-	-
60	Y101.060.M	-	-	-	-
70	Y101.070.M	-	-	-	-
80	Y101.080.M	-	-	-	-
90	Y101.090.M	-	-	-	-
100	Y101.100.M	-	-	-	-
120	Y101.120.M	-	-	-	-
140	Y101.140.M	-	-	-	-

#### 2 CAJONES / BANCADA

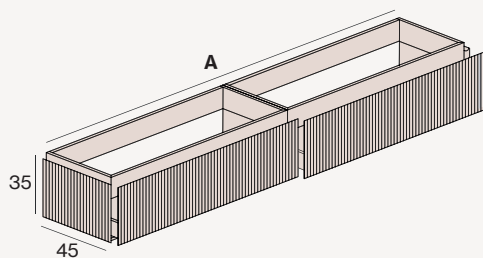

120	Y103.120.M	-	-	-	-
140	Y103.140.M	-	-	-	-
160	Y103.160.M	-	-	-	-
180	Y103.180.M	-	-	-	-
200	Y103.200.M	-	-	-	-



· Puede crear su mueble personalizado añadiendo los módulos a derecha y/o izquierda de la base de lavabo seleccionada. Especifique la posición de los mismos.

### MÓDULOS SUSPENDIDOS

#### 1 BAÚL

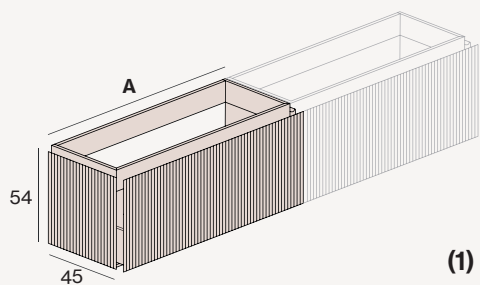

A (cm)	REF	LACA		MADERA TABLERO MARINO	
		FRONTAL FRISO	FRONTAL LISO	FRONTAL FRISO	FRONTAL LISO
30	Y202.030.M	-	-	-	-
40	Y202.040.M	-	-	-	-
60	Y202.060.M	-	-	-	-
70	Y202.070.M	-	-	-	-
80	Y202.080.M	-	-	-	-
90	Y202.090.M	-	-	-	-
100	Y202.100.M	-	-	-	-
120	Y202.120.M	-	-	-	-
140	Y202.140.M	-	-	-	-

### Complementos

#### & complementa

COMPLEMENTA  
TU MUEBLE  
Organizadores, toalleros,...  
pág. 148

#### (1) CAJÓN INTERIOR

El cajón interior se puede poner en las composiciones con baúl.

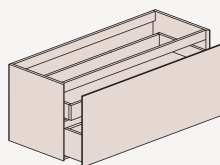

A (cm)	REF	PVP
40	A221.040	-
60	A221.060	-
70	A221.070	-
80	A221.080	-
90	A221.090	-
100	A221.100	-
120	A221.120	-
140	A221.140	-





# Diamond

Características y equipamiento	114
Personaliza tu mueble Diamond	115
Bases de lavabo suspendidas	116
Módulos suspendidos	120
Complementos Atelier	148



## DECOSPACE SYSTEM

Sistema que incluye el suministro de un sifón ahorra espacio y una válvula clic clac cromo brillo. Con esta solución se evita el cajeadado del cajón superior mejorando la capacidad de almacenamiento y estética interior ya que las instalaciones quedan ocultas.



## CAJONES 4D

Cajones metálicos Hettich o Blum de color antracita y de perfil extrafino de 12 mm con 4 regulaciones de ajuste. Las guías son de extracción total y sistema de frenado progresivo.



## A MEDIDA

Esta colección permite su fabricación a medida. En el caso de medidas intermedias de altura y anchura tomar el precio de la medida inmediatamente superior.



## ANTRACITA FULLCOLOR

Concepto de diseño interior por el que todos los materiales del interior de los muebles están diseñados en color antracita. Los muebles con acabado lacado se lacan interiormente en color antracita.



## DURALACK SYSTEM

Los colores lacados llevan unos aditivos endurecedores que permiten que el acabado final sea muy resistente al frote y a la abrasión.



## PUSH AND SLOW

Los cajones con sistema de apertura Push sin tirador llevan un sistema de sincronización que permite su apertura haciendo presión en cualquier punto del frontal. A su vez el cierre es progresivo y silencioso.



## DECOFIX SYSTEM

Sistema de fijación a pared de alta seguridad con el que las resistencias de carga son superiores a 240 kg.



## DECOBUILD SYSTEM

Los muebles fabricados con tableros de 19 mm están encolados entre sí con clavillas consiguiendo una estética limpia sin herrajes visibles y ofreciendo mejor resistencia y durabilidad.



## WOOD PROTECT SYSTEM

Las maderas tablero marino están protegidas contra los agentes externos con aceites naturales que respetan la textura y naturaleza de la madera.



## ATELIER SYSTEM

En los acabados de tablero marino se seleccionan las piezas de forma numerada para respetar la continuidad de la veta en todo el mueble.

## Configura y personaliza tu mueble Diamond

### A Escoge el tirador

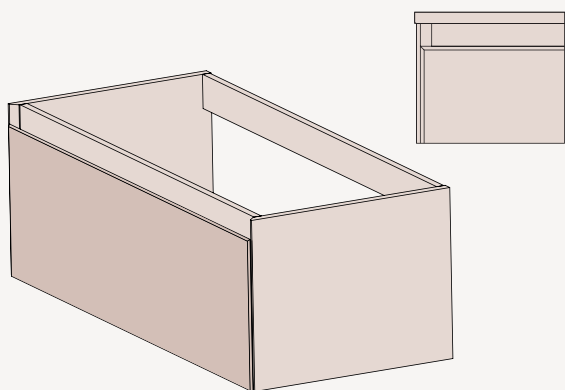

Diamond

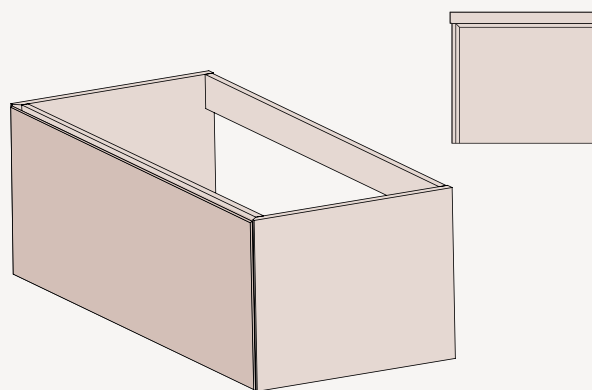

Push

### B Escoge el color

#### Lacados



#### Madera Tablero Marino / Chapa de Roble y Nogal

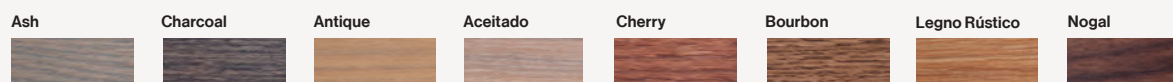

### BASES DE LAVABO SUSPENDIDAS

#### 1 CAJÓN

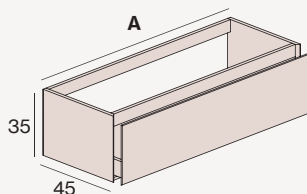

A (cm)	LAVABO	REF	LACA		MADERA TABLERO MARINO	
			TIRADOR DIAMOND	TIRADOR PUSH	TIRADOR DIAMOND	TIRADOR PUSH
60		D101.060.C	-	-	-	-
70		D101.070.C	-	-	-	-
80		D101.080.C	-	-	-	-
90		D101.090.C	-	-	-	-
100		D101.100.I	-	-	-	-
100		D101.100.C	-	-	-	-
100		D101.100.D	-	-	-	-
120		D101.120.I	-	-	-	-
120		D101.120.C	-	-	-	-
120		D101.120.D	-	-	-	-
120		D101.120.X	-	-	-	-
140		D101.140.I	-	-	-	-
140		D101.140.C	-	-	-	-
140		D101.140.D	-	-	-	-
140		D101.140.X	-	-	-	-

#### 2 CAJONES ASIMÉTRICOS

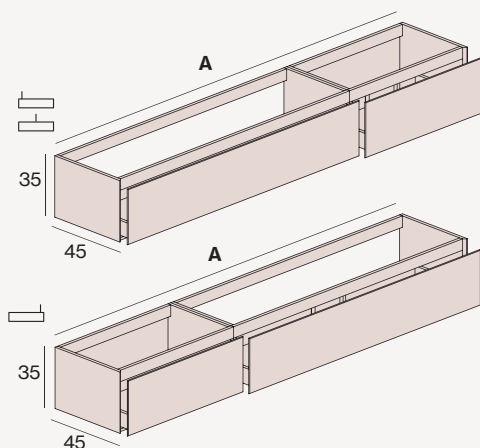

120		D102.120.I	-	-	-	-
120		D102.120.C	-	-	-	-
120		D102.120.D	-	-	-	-
140		D102.140.I	-	-	-	-
140		D102.140.C	-	-	-	-
140		D102.140.D	-	-	-	-
160		D102.160.I	-	-	-	-
160		D102.160.C	-	-	-	-
160		D102.160.D	-	-	-	-
180		D102.180.I	-	-	-	-
180		D102.180.C	-	-	-	-
180		D102.180.D	-	-	-	-
200		D102.200.I	-	-	-	-
200		D102.200.C	-	-	-	-
200		D102.200.D	-	-	-	-

#### 2 CAJONES SIMÉTRICOS

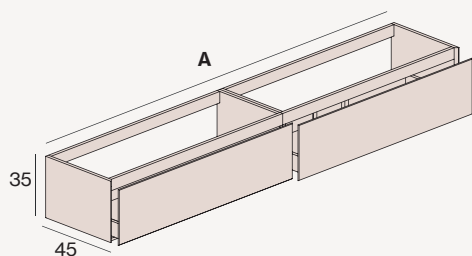

120		D103.120.I	-	-	-	-
120		D103.120.D	-	-	-	-
120		D103.120.X	-	-	-	-
140		D103.140.I	-	-	-	-
140		D103.140.D	-	-	-	-
140		D103.140.X	-	-	-	-
160		D103.160.I	-	-	-	-
160		D103.160.D	-	-	-	-
160		D103.160.X	-	-	-	-
180		D103.180.I	-	-	-	-
180		D103.180.D	-	-	-	-
180		D103.180.X	-	-	-	-
200		D103.200.I	-	-	-	-
200		D103.200.D	-	-	-	-
200		D103.200.X	-	-	-	-



- Las composiciones asimétricas tienen la siguiente modulación: 120 (80+40), 140 (100+40), 160 (100+60), 180 (120+60), 200 (120+80). Otras configuraciones disponibles.
- Muebles especiales: Para medidas intermedias en anchura y/o altura tomar el precio de la medida inmediatamente superior.
- El mueble de altura 35 no lleva sistema Decospace. Si la instalación lo permite se puede pedir sin sobreprecio.

- C Lavabo centrado
- D Lavabo derecho
- I Lavabo izquierdo
- X Lavabo doble

### BASES DE LAVABO SUSPENDIDAS

#### 2 CAJONES

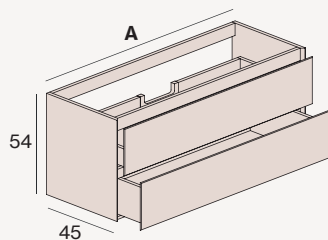

A (cm)	LAVABO	REF	LACA		MADERA TABLERO MARINO	
			TIRADOR DIAMOND	TIRADOR PUSH	TIRADOR DIAMOND	TIRADOR PUSH
60		D201.060.C	-	-	-	-
70		D201.070.C	-	-	-	-
80		D201.080.C	-	-	-	-
90		D201.090.C	-	-	-	-
100		D201.100.I	-	-	-	-
100		D201.100.C	-	-	-	-
100		D201.100.D	-	-	-	-
120		D201.120.I	-	-	-	-
120		D201.120.C	-	-	-	-
120		D201.120.D	-	-	-	-
120		D201.120.X	-	-	-	-
140		D201.140.I	-	-	-	-
140		D201.140.C	-	-	-	-
140		D201.140.D	-	-	-	-
140		D201.140.X	-	-	-	-

#### 1 BAÚL

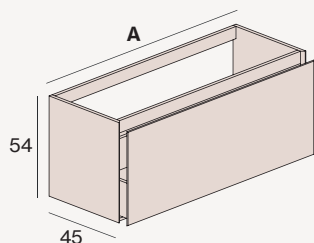

(1)

60		D202.060.C	-	-	-	-
70		D202.070.C	-	-	-	-
80		D202.080.C	-	-	-	-
90		D202.090.C	-	-	-	-
100		D202.100.I	-	-	-	-
100		D202.100.C	-	-	-	-
100		D202.100.D	-	-	-	-
120		D202.120.I	-	-	-	-
120		D202.120.C	-	-	-	-
120		D202.120.D	-	-	-	-
120		D202.120.X	-	-	-	-
140		D202.140.I	-	ND	-	ND
140		D202.140.C	-	ND	-	ND
140		D202.140.D	-	ND	-	ND
140		D202.140.X	-	ND	-	ND

#### 1 CAJÓN + DECORATIVO

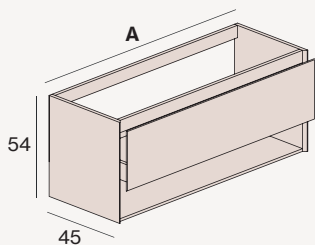

60		D203.060.C	-	-	-	-
70		D203.070.C	-	-	-	-
80		D203.080.C	-	-	-	-
90		D203.090.C	-	-	-	-
100		D203.100.I	-	-	-	-
100		D203.100.C	-	-	-	-
100		D203.100.D	-	-	-	-
120		D203.120.I	-	-	-	-
120		D203.120.C	-	-	-	-
120		D203.120.D	-	-	-	-
120		D203.120.X	-	-	-	-
140		D203.140.I	-	-	-	-
140		D203.140.C	-	-	-	-
140		D203.140.D	-	-	-	-
140		D203.140.X	-	-	-	-

Complementos

**& complementa**  
COMPLEMENTA  
TU MUEBLE  
Organizadores, toalleros,...  
pág. 148

#### (1) CAJÓN INTERIOR

El cajón interior se puede poner en las composiciones con baúl.

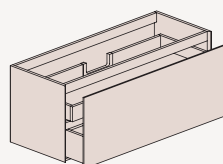

A (cm)	REF	PVP
40	A220.040	-
60	A220.060	-
70	A220.070	-
80	A220.080	-
90	A220.090	-
100	A220.100	-
120	A220.120	-
120X	A220.120X	-
140	A220.140	-
140X	A220.140X	-

### BASES DE LAVABO SUSPENDIDAS

#### BAÚL + 2 CAJONES ASIMÉTRICOS

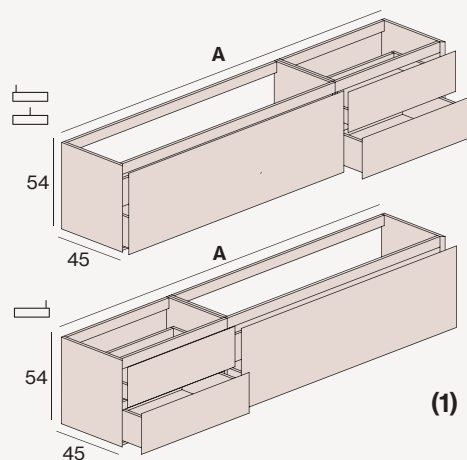

#### BAÚL + 2 CAJONES SIMÉTRICOS

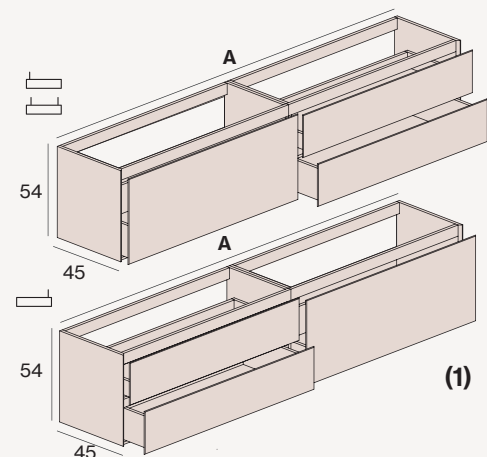

#### 4 CAJONES ASIMÉTRICOS

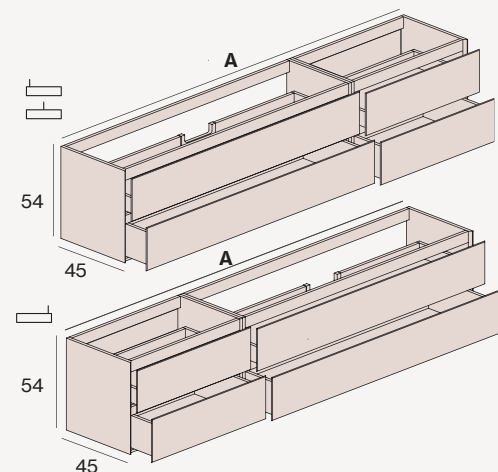

A (cm)	LAVABO	REF	LACA		MADERA TABLERO MARINO	
			TIRADOR DIAMOND	TIRADOR PUSH	TIRADOR DIAMOND	TIRADOR PUSH
120		D205.120.I	-	-	-	-
120		D205.120.C	-	-	-	-
120		D205.120.D	-	-	-	-
140		D205.140.I	-	-	-	-
140		D205.140.C	-	-	-	-
140		D205.140.D	-	-	-	-
160		D205.160.I	-	-	-	-
160		D205.160.C	-	-	-	-
160		D205.160.D	-	-	-	-
180		D205.180.I	-	-	-	-
180		D205.180.C	-	-	-	-
180		D205.180.D	-	-	-	-
200		D205.200.I	-	-	-	-
200		D205.200.C	-	-	-	-
200		D205.200.D	-	-	-	-
<hr/>						
120		D206.120.I	-	-	-	-
120		D206.120.D	-	-	-	-
120		D206.120.X	-	-	-	-
140		D206.140.I	-	-	-	-
140		D206.140.D	-	-	-	-
140		D206.140.X	-	-	-	-
160		D206.160.I	-	-	-	-
160		D206.160.D	-	-	-	-
160		D206.160.X	-	-	-	-
180		D206.180.I	-	-	-	-
180		D206.180.D	-	-	-	-
180		D206.180.X	-	-	-	-
200		D206.200.I	-	-	-	-
200		D206.200.D	-	-	-	-
200		D206.200.X	-	-	-	-
<hr/>						
120		D208.120.I	-	-	-	-
120		D208.120.C	-	-	-	-
120		D208.120.D	-	-	-	-
140		D208.140.I	-	-	-	-
140		D208.140.C	-	-	-	-
140		D208.140.D	-	-	-	-
160		D208.160.I	-	-	-	-
160		D208.160.C	-	-	-	-
160		D208.160.D	-	-	-	-
180		D208.180.I	-	-	-	-
180		D208.180.C	-	-	-	-
180		D208.180.D	-	-	-	-
200		D208.200.I	-	-	-	-
200		D208.200.C	-	-	-	-
200		D208.200.D	-	-	-	-



- Las composiciones asimétricas tienen la siguiente modulación: 120 (80+40), 140 (100+40), 160 (100+60), 180 (120+60), 200 (120+80). Otras configuraciones disponibles.
- Muebles especiales: Para medidas intermedias en anchura y/o altura tomar el precio de la medida inmediatamente superior.
- El mueble de altura 35 no lleva sistema Decospace. Si la instalación lo permite se puede pedir sin sobreprecio.

- C Lavabo centrado
- D Lavabo derecho
- I Lavabo izquierdo
- X Lavabo doble

### BASES DE LAVABO SUSPENDIDAS

#### 4 CAJONES SIMÉTRICOS

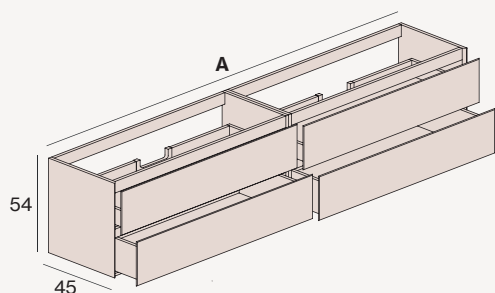

#### 2 BAULES ASIMÉTRICOS

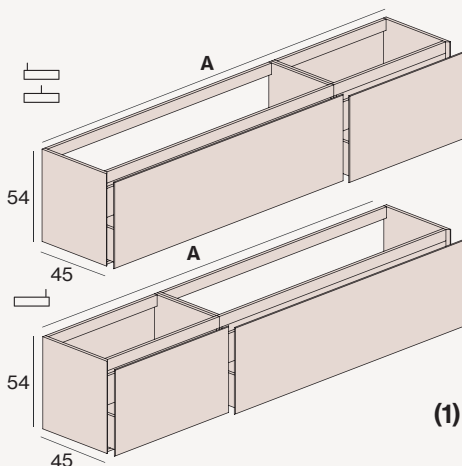

#### 2 BAULES SIMÉTRICOS

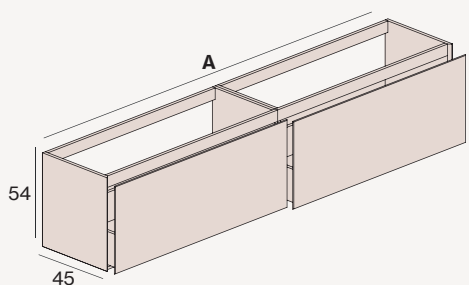

Complementos

A (cm)	LAVABO	REF	LACA		MADERA TABLERO MARINO	
			TIRADOR DIAMOND	TIRADOR PUSH	TIRADOR DIAMOND	TIRADOR PUSH
120		D209.120.I	-	-	-	-
120		D209.120.D	-	-	-	-
120		D209.120.X	-	-	-	-
140		D209.140.I	-	-	-	-
140		D209.140.D	-	-	-	-
140		D209.140.X	-	-	-	-
160		D209.160.I	-	-	-	-
160		D209.160.D	-	-	-	-
160		D209.160.X	-	-	-	-
180		D209.180.I	-	-	-	-
180		D209.180.D	-	-	-	-
180		D209.180.X	-	-	-	-
200		D209.200.I	-	-	-	-
200		D209.200.D	-	-	-	-
200		D209.200.X	-	-	-	-
120		D210.120.I	-	-	-	-
120		D210.120.C	-	-	-	-
120		D210.120.D	-	-	-	-
140		D210.140.I	-	-	-	-
140		D210.140.C	-	-	-	-
140		D210.140.D	-	-	-	-
160		D210.160.I	-	-	-	-
160		D210.160.C	-	-	-	-
160		D210.160.D	-	-	-	-
180		D210.180.I	-	-	-	-
180		D210.180.C	-	-	-	-
180		D210.180.D	-	-	-	-
200		D210.200.I	-	-	-	-
200		D210.200.C	-	-	-	-
200		D210.200.D	-	-	-	-
120		D211.120.I	-	-	-	-
120		D211.120.D	-	-	-	-
120		D211.120.X	-	-	-	-
140		D211.140.I	-	-	-	-
140		D211.140.D	-	-	-	-
140		D211.140.X	-	-	-	-
160		D211.160.I	-	-	-	-
160		D211.160.D	-	-	-	-
160		D211.160.X	-	-	-	-
180		D211.180.I	-	-	-	-
180		D211.180.D	-	-	-	-
180		D211.180.X	-	-	-	-
200		D211.200.I	-	-	-	-
200		D211.200.D	-	-	-	-
200		D211.200.X	-	-	-	-

#### & complementa

COMPLEMENTA TU MUEBLE  
Organizadores, toalleros,...  
pág. 148

#### (1) CAJÓN INTERIOR

El cajón interior se puede poner en las composiciones con baúl.

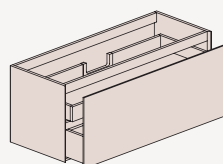

A (cm)	REF	PVP
40	A220.040	-
60	A220.060	-
70	A220.070	-
80	A220.080	-
90	A220.090	-
100	A220.100	-
120	A220.120	-
120X	A220.120X	-
140	A220.140	-
140X	A220.140X	-

### MÓDULOS SUSPENDIDOS

#### 1 CAJÓN / BANCADA

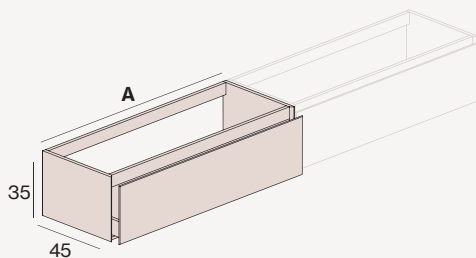

A (cm)	REF	LACA		MADERA TABLERO MARINO	
		TIRADOR DIAMOND	TIRADOR PUSH	TIRADOR DIAMOND	TIRADOR PUSH
30	D101.030.M	-	-	-	-
40	D101.040.M	-	-	-	-
60	D101.060.M	-	-	-	-
70	D101.070.M	-	-	-	-
80	D101.080.M	-	-	-	-
90	D101.090.M	-	-	-	-
100	D101.100.M	-	-	-	-
120	D101.120.M	-	-	-	-
140	D101.140.M	-	-	-	-

#### 2 CAJONES / BANCADA

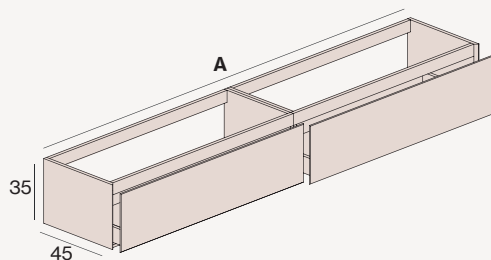

120	D103.120.M	-	-	-	-
140	D103.140.M	-	-	-	-
160	D103.160.M	-	-	-	-
180	D103.180.M	-	-	-	-
200	D103.200.M	-	-	-	-

#### DECORATIVO

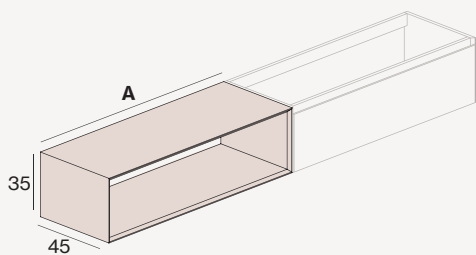

30	D104.030.M	-	-	-	-
40	D104.040.M	-	-	-	-
60	D104.060.M	-	-	-	-
70	D104.070.M	-	-	-	-
80	D104.080.M	-	-	-	-



· Puede crear su mueble personalizado añadiendo los módulos a derecha y/o izquierda de la base de lavabo seleccionada. Especifique la posición de los mismos.



### MÓDULOS SUSPENDIDOS

#### 1 BAÚL

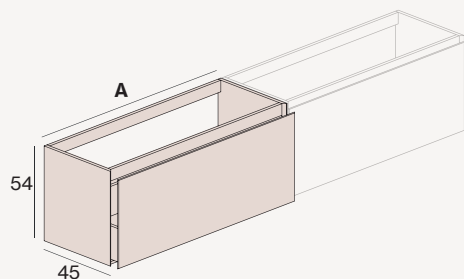

(1)

#### 1 CAJÓN + DECORATIVO

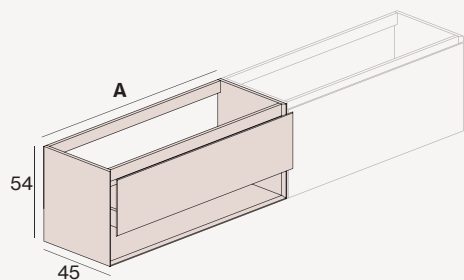

#### 2 CAJONES

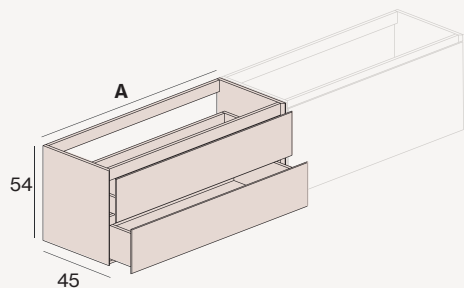

#### DECORATIVO 2 ESTANTES

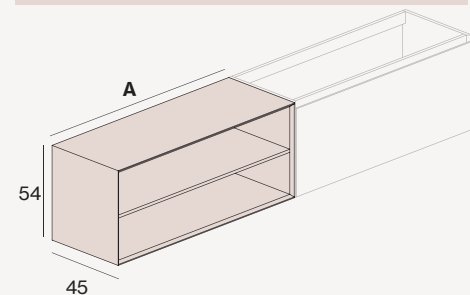

**& complementa**  
COMPLEMENTA  
TU MUEBLE  
Organizadores, toalleros,...  
pág. 148

A (cm)	REF	LACA		MADERA TABLERO MARINO	
		TIRADOR DIAMOND	TIRADOR PUSH	TIRADOR DIAMOND	TIRADOR PUSH
30	D202.030.M	-	-	-	-
40	D202.040.M	-	-	-	-
60	D202.060.M	-	-	-	-
70	D202.070.M	-	-	-	-
80	D202.080.M	-	-	-	-
90	D202.090.M	-	-	-	-
100	D202.100.M	-	-	-	-
120	D202.120.M	-	-	-	-
140	D202.140.M	-	ND	-	ND

30	D203.030.M	-	-	-	-
40	D203.040.M	-	-	-	-
60	D203.060.M	-	-	-	-
70	D203.070.M	-	-	-	-
80	D203.080.M	-	-	-	-
90	D203.090.M	-	-	-	-
100	D203.100.M	-	-	-	-
120	D203.120.M	-	-	-	-
140	D203.140.M	-	-	-	-

30	D201.030.M	-	-	-	-
40	D201.040.M	-	-	-	-
60	D201.060.M	-	-	-	-
70	D201.070.M	-	-	-	-
80	D201.080.M	-	-	-	-
90	D201.090.M	-	-	-	-
100	D201.100.M	-	-	-	-
120	D201.120.M	-	-	-	-
140	D201.140.M	-	-	-	-

30	D207.030.M	-	-	-	-
40	D207.040.M	-	-	-	-
60	D207.060.M	-	-	-	-
70	D207.070.M	-	-	-	-
80	D207.080.M	-	-	-	-



#### (1) CAJÓN INTERIOR

El cajón interior se puede poner en las composiciones con baúl.

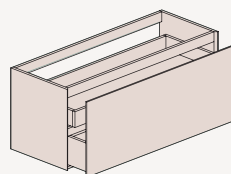

A (cm)	REF	PVP
40	A221.040	-
60	A221.060	-
70	A221.070	-
80	A221.080	-
90	A221.090	-
100	A221.100	-
120	A221.120	-
140	A221.140	-



# Best

Características y equipamiento	124
Personaliza tu mueble Best	125
Bases de lavabo suspendidas	126
Módulos suspendidos	130
Complementos Atelier	148



### DECOSPACE SYSTEM

Sistema que incluye el suministro de un sifón ahorra espacio y una válvula clic clac cromo brillo. Con esta solución se evita el cajeadado del cajón superior mejorando la capacidad de almacenamiento y estética interior ya que las instalaciones quedan ocultas.



### CAJONES 4D

Cajones metálicos Hettich o Blum de color antracita y de perfil extrafino de 12 mm con 4 regulaciones de ajuste. Las guías son de extracción total y sistema de frenado progresivo.



### A MEDIDA

Esta colección permite su fabricación a medida. En el caso de medidas intermedias de altura y anchura tomar el precio de la medida inmediatamente superior.



### ANTRACITA FULLCOLOR

Concepto de diseño interior por el que todos los materiales del interior de los muebles están diseñados en color antracita. Los muebles con acabado lacado se lacan interiormente en color antracita.



### DURALACK SYSTEM

Los colores lacados llevan unos aditivos endurecedores que permiten que el acabado final sea muy resistente al frote y a la abrasión.



### PUSH AND SLOW

Los cajones con sistema de apertura Push sin tirador llevan un sistema de sincronización que permite su apertura haciendo presión en cualquier punto del frontal. A su vez el cierre es progresivo y silencioso.



### DECOFIX SYSTEM

Sistema de fijación a pared de alta seguridad con el que las resistencias de carga son superiores a 240 kg.



### DECOBUILD SYSTEM

Los muebles fabricados con tableros de 19 mm están encolados entre sí con clavillas consiguiendo una estética limpia sin herrajes visibles y ofreciendo mejor resistencia y durabilidad.



### WOOD PROTECT SYSTEM

Las maderas tablero marino están protegidas contra los agentes externos con aceites naturales que respetan la textura y naturaleza de la madera.



### ATELIER SYSTEM

En los acabados de tablero marino se seleccionan las piezas de forma numerada para respetar la continuidad de la veta en todo el mueble.

## Configura y personaliza tu mueble Best

### A Escoge el tirador

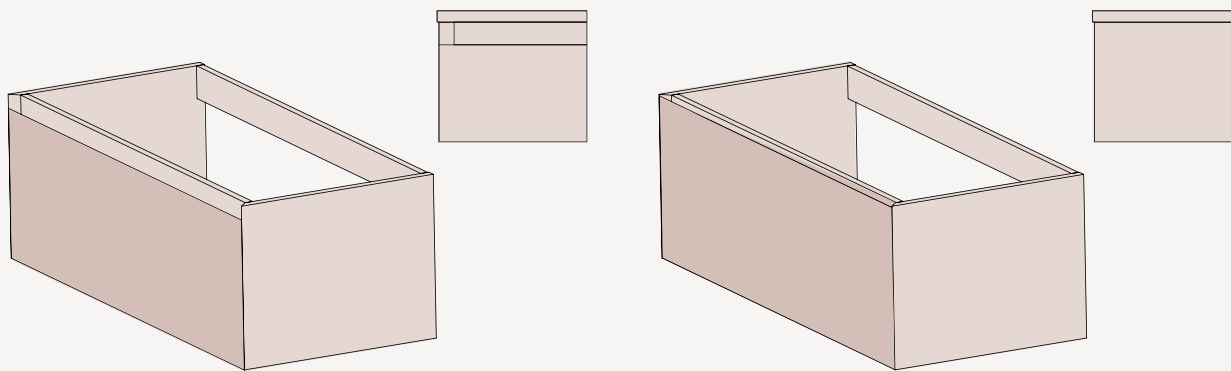

Best

Push

### B Escoge el color

#### Lacados



#### Madera Tablero Marino / Chapa de Roble y Nogal

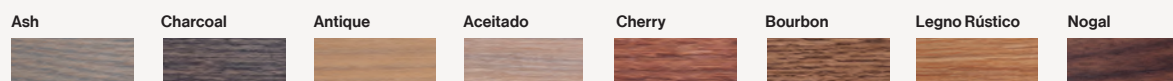

BASES DE LAVABO SUSPENDIDAS

1 CAJÓN

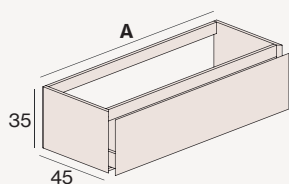

A (cm)	LAVABO	REF	LACA		MADERA TABLERO MARINO	
			TIRADOR BEST	TIRADOR PUSH	TIRADOR BEST	TIRADOR PUSH
60		B101.060.C	-	-	-	-
70		B101.070.C	-	-	-	-
80		B101.080.C	-	-	-	-
90		B101.090.C	-	-	-	-
100		B101.100.I	-	-	-	-
100		B101.100.C	-	-	-	-
100		B101.100.D	-	-	-	-
120		B101.120.I	-	-	-	-
120		B101.120.C	-	-	-	-
120		B101.120.D	-	-	-	-
120		B101.120.X	-	-	-	-
140		B101.140.I	-	-	-	-
140		B101.140.C	-	-	-	-
140		B101.140.D	-	-	-	-
140		B101.140.X	-	-	-	-

2 CAJONES ASIMÉTRICOS

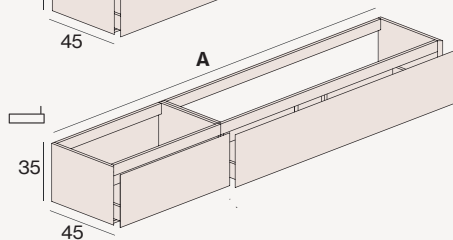
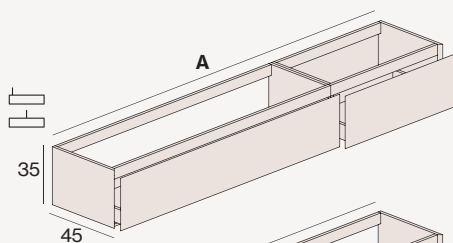

120		B102.120.I	-	-	-	-
120		B102.120.C	-	-	-	-
120		B102.120.D	-	-	-	-
140		B102.140.I	-	-	-	-
140		B102.140.C	-	-	-	-
140		B102.140.D	-	-	-	-
160		B102.160.I	-	-	-	-
160		B102.160.C	-	-	-	-
160		B102.160.D	-	-	-	-
180		B102.180.I	-	-	-	-
180		B102.180.C	-	-	-	-
180		B102.180.D	-	-	-	-
200		B102.200.I	-	-	-	-
200		B102.200.C	-	-	-	-
200		B102.200.D	-	-	-	-

2 CAJONES SIMÉTRICOS

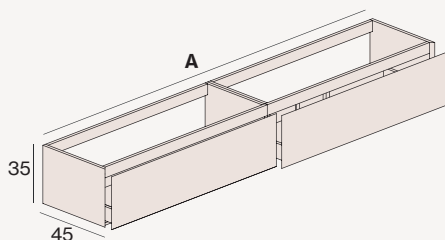

120		B103.120.I	-	-	-	-
120		B103.120.D	-	-	-	-
120		B103.120.X	-	-	-	-
140		B103.140.I	-	-	-	-
140		B103.140.D	-	-	-	-
140		B103.140.X	-	-	-	-
160		B103.160.I	-	-	-	-
160		B103.160.D	-	-	-	-
160		B103.160.X	-	-	-	-
180		B103.180.I	-	-	-	-
180		B103.180.D	-	-	-	-
180		B103.180.X	-	-	-	-
200		B103.200.I	-	-	-	-
200		B103.200.D	-	-	-	-
200		B103.200.X	-	-	-	-



- Las composiciones asimétricas tienen la siguiente modulación: 120 (80+40), 140 (100+40), 160 (100+60), 180 (120+60), 200 (120+80). Otras configuraciones disponibles.
- Muebles especiales: Para medidas intermedias en anchura y/o altura tomar el precio de la medida inmediatamente superior.
- El mueble de altura 35 no lleva sistema Decospace. Si la instalación lo permite se puede pedir sin sobreprecio.

- C Lavabo centrado
- D Lavabo derecho
- I Lavabo izquierdo
- X Lavabo doble

### BASES DE LAVABO SUSPENDIDAS

#### 2 CAJONES

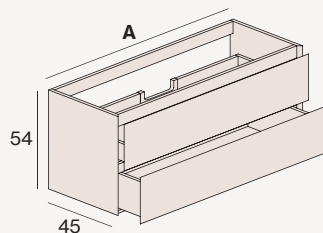

A (cm)	LAVABO	REF	LACA		MADERA TABLERO MARINO	
			TIRADOR BEST	TIRADOR PUSH	TIRADOR BEST	TIRADOR PUSH
60		B201.060.C	-	-	-	-
70		B201.070.C	-	-	-	-
80		B201.080.C	-	-	-	-
90		B201.090.C	-	-	-	-
100		B201.100.I	-	-	-	-
100		B201.100.C	-	-	-	-
100		B201.100.D	-	-	-	-
120		B201.120.I	-	-	-	-
120		B201.120.C	-	-	-	-
120		B201.120.D	-	-	-	-
120		B201.120.X	-	-	-	-
140		B201.140.I	-	-	-	-
140		B201.140.C	-	-	-	-
140		B201.140.D	-	-	-	-
140		B201.140.X	-	-	-	-

#### 1 BAÚL

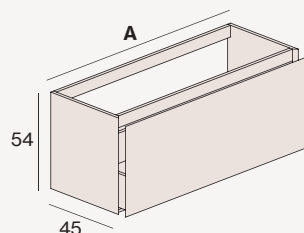

(1)

60		B202.060.C	-	-	-	-
70		B202.070.C	-	-	-	-
80		B202.080.C	-	-	-	-
90		B202.090.C	-	-	-	-
100		B202.100.I	-	-	-	-
100		B202.100.C	-	-	-	-
100		B202.100.D	-	-	-	-
120		B202.120.I	-	-	-	-
120		B202.120.C	-	-	-	-
120		B202.120.D	-	-	-	-
120		B202.120.X	-	-	-	-
140		B202.140.I	-	ND	-	ND
140		B202.140.C	-	ND	-	ND
140		B202.140.D	-	ND	-	ND
140		B202.140.X	-	ND	-	ND

#### 1 CAJÓN + DECORATIVO

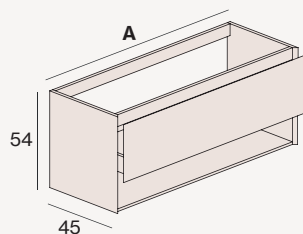

60		B203.060.C	-	-	-	-
70		B203.070.C	-	-	-	-
80		B203.080.C	-	-	-	-
90		B203.090.C	-	-	-	-
100		B203.100.I	-	-	-	-
100		B203.100.C	-	-	-	-
100		B203.100.D	-	-	-	-
120		B203.120.I	-	-	-	-
120		B203.120.C	-	-	-	-
120		B203.120.D	-	-	-	-
120		B203.120.X	-	-	-	-
140		B203.140.I	-	-	-	-
140		B203.140.C	-	-	-	-
140		B203.140.D	-	-	-	-
140		B203.140.X	-	-	-	-

Complementos

#### & complementa

COMPLEMENTA TU MUEBLE  
Organizadores, toalleros,...  
pág. 148

#### (1) CAJÓN INTERIOR

El cajón interior se puede poner en las composiciones con baúl.

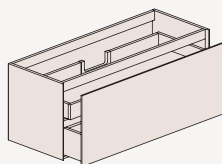

A (cm)	REF	PVP
40	A220.040	-
60	A220.060	-
70	A220.070	-
80	A220.080	-
90	A220.090	-
100	A220.100	-
120	A220.120	-
120X	A220.120X	-
140	A220.140	-
140X	A220.140X	-

BASES DE LAVABO SUSPENDIDAS

1 BAÚL + 2 CAJONES ASIMÉTRICOS

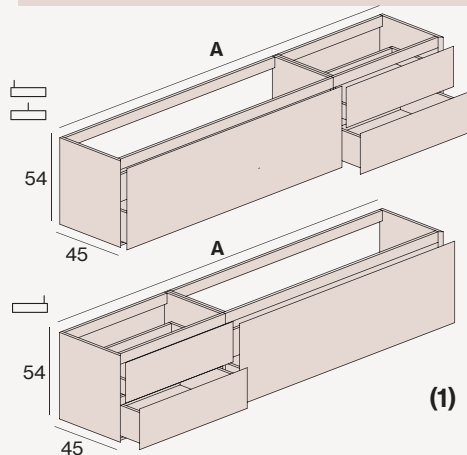

1 BAÚL + 2 CAJONES SIMÉTRICOS

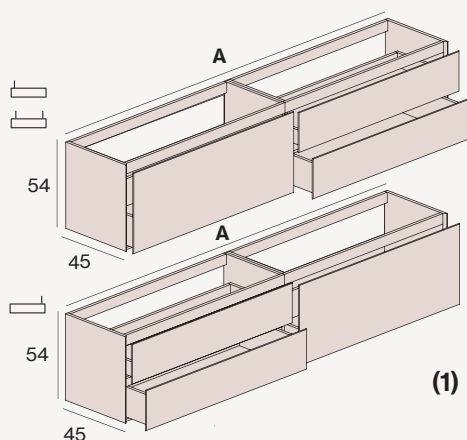

4 CAJONES ASIMÉTRICOS

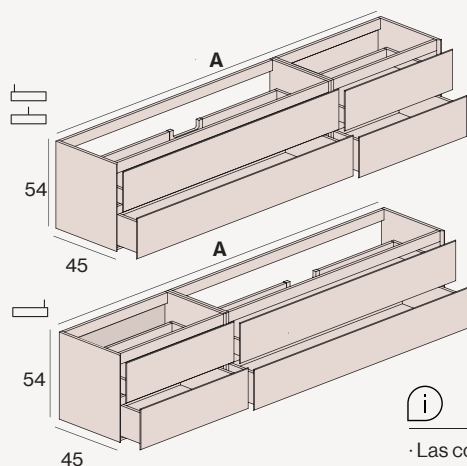

A (cm)	LAVABO	REF	LACA		MADERA TABLERO MARINO	
			TIRADOR BEST	TIRADOR PUSH	TIRADOR BEST	TIRADOR PUSH
120		B205.120.I	-	-	-	-
120		B205.120.C	-	-	-	-
120		B205.120.D	-	-	-	-
140		B205.140.I	-	-	-	-
140		B205.140.C	-	-	-	-
140		B205.140.D	-	-	-	-
160		B205.160.I	-	-	-	-
160		B205.160.C	-	-	-	-
160		B205.160.D	-	-	-	-
180		B205.180.I	-	-	-	-
180		B205.180.C	-	-	-	-
180		B205.180.D	-	-	-	-
200		B205.200.I	-	-	-	-
200		B205.200.C	-	-	-	-
200		B205.200.D	-	-	-	-
<hr/>						
120		B206.120.I	-	-	-	-
120		B206.120.D	-	-	-	-
120		B206.120.X	-	-	-	-
140		B206.140.I	-	-	-	-
140		B206.140.D	-	-	-	-
140		B206.140.X	-	-	-	-
160		B206.160.I	-	-	-	-
160		B206.160.D	-	-	-	-
160		B206.160.X	-	-	-	-
180		B206.180.I	-	-	-	-
180		B206.180.D	-	-	-	-
180		B206.180.X	-	-	-	-
200		B206.200.I	-	-	-	-
200		B206.200.D	-	-	-	-
200		B206.200.X	-	-	-	-
<hr/>						
120		B208.120.I	-	-	-	-
120		B208.120.C	-	-	-	-
120		B208.120.D	-	-	-	-
140		B208.140.I	-	-	-	-
140		B208.140.C	-	-	-	-
140		B208.140.D	-	-	-	-
160		B208.160.I	-	-	-	-
160		B208.160.C	-	-	-	-
160		B208.160.D	-	-	-	-
180		B208.180.I	-	-	-	-
180		B208.180.C	-	-	-	-
180		B208.180.D	-	-	-	-
200		B208.200.I	-	-	-	-
200		B208.200.C	-	-	-	-
200		B208.200.D	-	-	-	-



· Las composiciones asimétricas tienen la siguiente modulación:  
120 (80+40), 140 (100+40), 160 (100+60), 180 (120+60), 200 (120+80).  
Otras configuraciones disponibles.

· Muebles especiales: Para medidas intermedias en anchura y/o altura tomar el precio de la medida inmediatamente superior.

· El mueble de altura 35 no lleva sistema Decospace. Si la instalación lo permite se puede pedir sin sobreprecio.

- C Lavabo centrado
- D Lavabo derecho
- I Lavabo izquierdo
- X Lavabo doble



BASES DE LAVABO SUSPENDIDAS

4 CAJONES SIMÉTRICOS

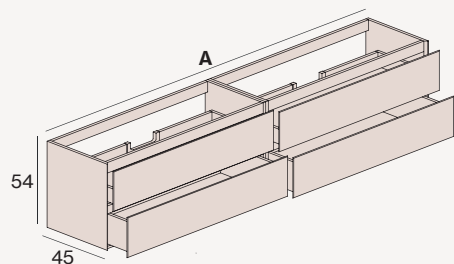

A (cm)	LAVABO	REF	LACA		MADERA TABLERO MARINO	
			TIRADOR BEST	TIRADOR PUSH	TIRADOR BEST	TIRADOR PUSH
120		B209.120.I	-	-	-	-
120		B209.120.D	-	-	-	-
120		B209.120.X	-	-	-	-
140		B209.140.I	-	-	-	-
140		B209.140.D	-	-	-	-
140		B209.140.X	-	-	-	-
160		B209.160.I	-	-	-	-
160		B209.160.D	-	-	-	-
160		B209.160.X	-	-	-	-
180		B209.180.I	-	-	-	-
180		B209.180.D	-	-	-	-
180		B209.180.X	-	-	-	-
200		B209.200.I	-	-	-	-
200		B209.200.D	-	-	-	-
200		B209.200.X	-	-	-	-

2 BAÚLES ASIMÉTRICOS

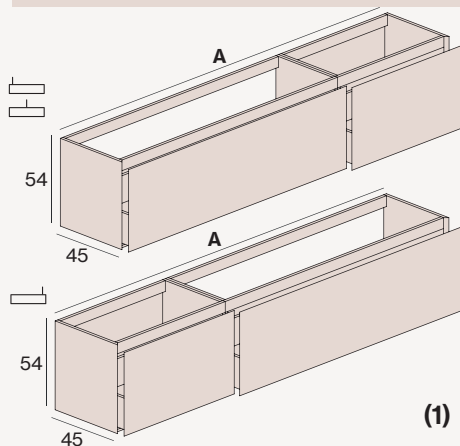

120		B210.120.I	-	-	-	-
120		B210.120.C	-	-	-	-
120		B210.120.D	-	-	-	-
140		B210.140.I	-	-	-	-
140		B210.140.C	-	-	-	-
140		B210.140.D	-	-	-	-
160		B210.160.I	-	-	-	-
160		B210.160.C	-	-	-	-
160		B210.160.D	-	-	-	-
180		B210.180.I	-	-	-	-
180		B210.180.C	-	-	-	-
180		B210.180.D	-	-	-	-
200		B210.200.I	-	-	-	-
200		B210.200.C	-	-	-	-
200		B210.200.D	-	-	-	-

2 BAÚLES SIMÉTRICOS

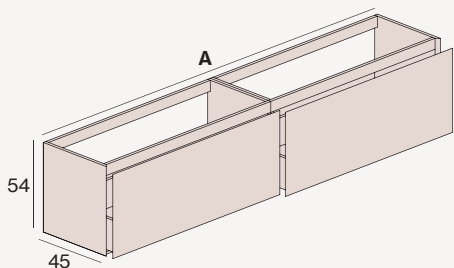

120		B211.120.I	-	-	-	-
120		B211.120.D	-	-	-	-
120		B211.120.X	-	-	-	-
140		B211.140.I	-	-	-	-
140		B211.140.D	-	-	-	-
140		B211.140.X	-	-	-	-
160		B211.160.I	-	-	-	-
160		B211.160.D	-	-	-	-
160		B211.160.X	-	-	-	-
180		B211.180.I	-	-	-	-
180		B211.180.D	-	-	-	-
180		B211.180.X	-	-	-	-
200		B211.200.I	-	-	-	-
200		B211.200.D	-	-	-	-
200		B211.200.X	-	-	-	-

Complementos

**& complementa**  
COMPLEMENTA  
TU MUEBLE  
Organizadores, toalleros,...  
pág. 148

(1) CAJÓN INTERIOR

El cajón interior se puede poner en las composiciones con baúl.

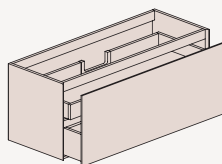

A (cm)	REF	PVP
40	A220.040	-
60	A220.060	-
70	A220.070	-
80	A220.080	-
90	A220.090	-
100	A220.100	-
120	A220.120	-
120X	A220.120X	-
140	A220.140	-
140X	A220.140X	-

MÓDULOS SUSPENDIDOS

1 CAJÓN / BANCADA

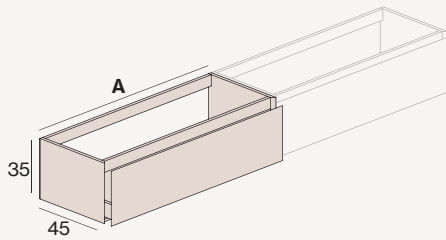

A (cm)	REF	LACA		MADERA TABLERO MARINO	
		TIRADOR BEST	TIRADOR PUSH	TIRADOR BEST	TIRADOR PUSH
30	B101.030.M	-	-	-	-
40	B101.040.M	-	-	-	-
60	B101.060.M	-	-	-	-
70	B101.070.M	-	-	-	-
80	B101.080.M	-	-	-	-
90	B101.090.M	-	-	-	-
100	B101.100.M	-	-	-	-
120	B101.120.M	-	-	-	-
140	B101.140.M	-	-	-	-

2 CAJONES / BANCADA

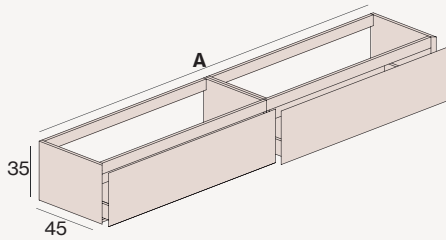

120	B103.120.M	-	-	-	-
140	B103.140.M	-	-	-	-
160	B103.160.M	-	-	-	-
180	B103.180.M	-	-	-	-
200	B103.200.M	-	-	-	-

DECORATIVO

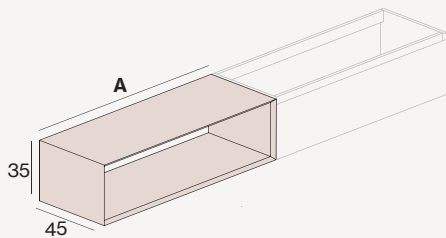

30	B104.030.M	-	-	-	-
40	B104.040.M	-	-	-	-
60	B104.060.M	-	-	-	-
70	B104.070.M	-	-	-	-
80	B104.080.M	-	-	-	-

### MÓDULOS SUSPENDIDOS

#### 1 BAÚL

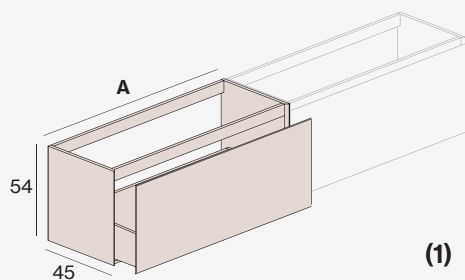

A (cm)	REF	LACA		MADERA TABLERO MARINO	
		TIRADOR BEST	TIRADOR PUSH	TIRADOR BEST	TIRADOR PUSH
30	B202.030.M	-	-	-	-
40	B202.040.M	-	-	-	-
60	B202.060.M	-	-	-	-
70	B202.070.M	-	-	-	-
80	B202.080.M	-	-	-	-
90	B202.090.M	-	-	-	-
100	B202.100.M	-	-	-	-
120	B202.120.M	-	-	-	-
140	B202.140.M	-	ND	-	ND

#### 1 CAJÓN + DECORATIVO

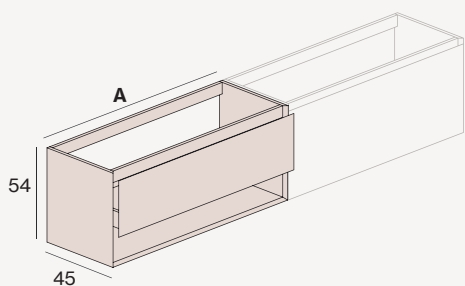

30	B203.030.M	-	-	-	-
40	B203.040.M	-	-	-	-
60	B203.060.M	-	-	-	-
70	B203.070.M	-	-	-	-
80	B203.080.M	-	-	-	-
90	B203.090.M	-	-	-	-
100	B203.100.M	-	-	-	-
120	B203.120.M	-	-	-	-
140	B203.140.M	-	-	-	-

#### 2 CAJONES

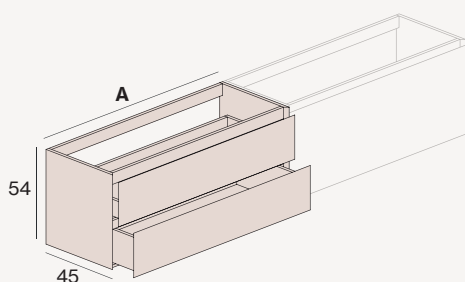

30	B201.030.M	-	-	-	-
40	B201.040.M	-	-	-	-
60	B201.060.M	-	-	-	-
70	B201.070.M	-	-	-	-
80	B201.080.M	-	-	-	-
90	B201.090.M	-	-	-	-
100	B201.100.M	-	-	-	-
120	B201.120.M	-	-	-	-
140	B201.140.M	-	-	-	-

#### DECORATIVO 2 ESTANTES

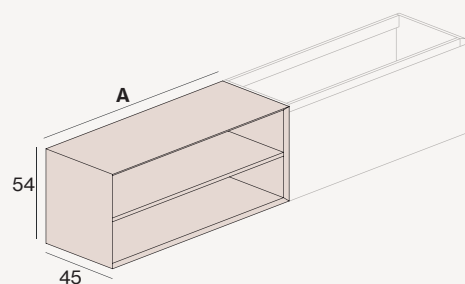

30	B207.030.M	-	-	-	-
40	B207.040.M	-	-	-	-
60	B207.060.M	-	-	-	-
70	B207.070.M	-	-	-	-
80	B207.080.M	-	-	-	-

#### (1) CAJÓN INTERIOR

El cajón interior se puede poner en las composiciones con baúl.

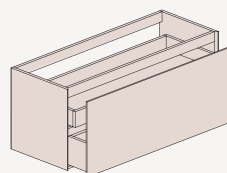

A (cm)	REF	PVP
40	A221.040	-
60	A221.060	-
70	A221.070	-
80	A221.080	-
90	A221.090	-
100	A221.100	-
120	A221.120	-
140	A221.140	-



· Puede crear su mueble personalizado añadiendo los módulos a derecha y/o izquierda de la base de lavabo seleccionada. Especifique la posición de los mismos.

**& complementa**  
COMPLEMENTA TU MUEBLE  
Organizadores, toalleros,...  
pág. 148



# Queen

Características y equipamiento	134
Personaliza tu mueble Queen	135
Bases de lavabo suspendidas	136
Módulos suspendidos	139
Complementos Atelier	148

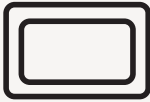

#### DECOSPACE SYSTEM

Sistema que incluye el suministro de un sifón ahorra espacio y una válvula clic clac cromo brillo. Con esta solución se evita el cajeadado del cajón superior mejorando la capacidad de almacenamiento y estética interior ya que las instalaciones quedan ocultas.



#### CAJONES 4D

Cajones metálicos Hettich o Blum de color antracita y de perfil extrafino de 12 mm con 4 regulaciones de ajuste. Las guías son de extracción total y sistema de frenado progresivo.



#### A MEDIDA

Esta colección permite su fabricación a medida. En el caso de medidas intermedias de altura y anchura tomar el precio de la medida inmediatamente superior.



#### ANTRACITA FULLCOLOR

Concepto de diseño interior por el que todos los materiales del interior de los muebles están diseñados en color antracita. Los muebles con acabado lacado se lacan interiormente en color antracita.



#### DURALACK SYSTEM

Los colores lacados llevan unos aditivos endurecedores que permiten que el acabado final sea muy resistente al frote y a la abrasión.



#### DECOFIX SYSTEM

Sistema de fijación a pared de alta seguridad con el que las resistencias de carga son superiores a 240 kg.



#### DECOBUILD SYSTEM

Los muebles fabricados con tableros de 19 mm están encolados entre sí con clavillas consiguiendo una estética limpia sin herrajes visibles y ofreciendo mejor resistencia y durabilidad.

Queen te lo pone muy fácil. Para personalizar tu mueble, únicamente tienes que escoger el color y el tirador deseado

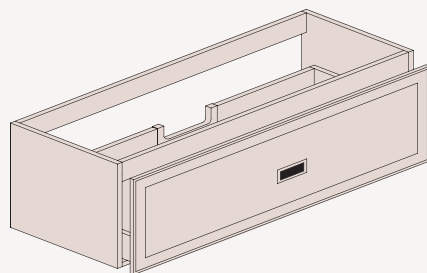

**A** Escoge tu color lacado



\* Disponible en todos los colores RAL

**B** Escoge tu tirador

Oro brillo

Arista decorada



Tirador

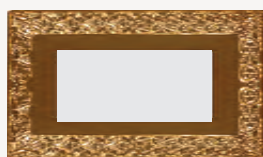

Cromo brillo

Arista decorada



Tirador



### BASES DE LAVABO SUSPENDIDAS

#### 1 CAJÓN

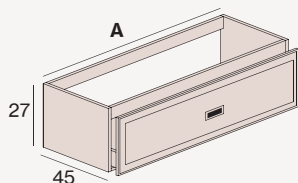

A (cm)	LAVABO	REF	PVP
60		Q101.060.C	-
70		Q101.070.C	-
80		Q101.080.C	-
90		Q101.090.C	-
100		Q101.100.I	-
100		Q101.100.C	-
100		Q101.100.D	-
120		Q101.120.I	-
120		Q101.120.C	-
120		Q101.120.D	-
120		Q101.120.X	-
140		Q101.140.I	-
140		Q101.140.C	-
140		Q101.140.D	-
140		Q101.140.X	-

#### 2 CAJONES ASIMÉTRICOS

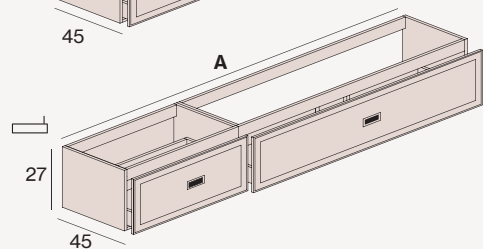
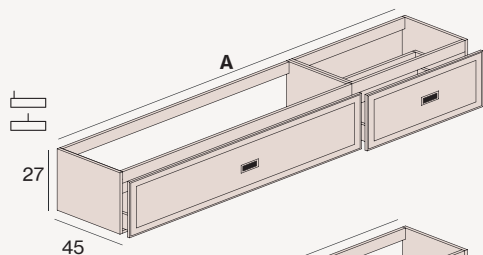

120		Q102.120.I	-
120		Q102.120.C	-
120		Q102.120.D	-
140		Q102.140.I	-
140		Q102.140.C	-
140		Q102.140.D	-
160		Q102.160.I	-
160		Q102.160.C	-
160		Q102.160.D	-
180		Q102.180.I	-
180		Q102.180.C	-
180		Q102.180.D	-
200		Q102.200.I	-
200		Q102.200.C	-
200		Q102.200.D	-

#### 2 CAJONES SIMÉTRICOS

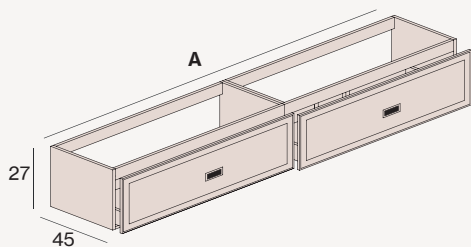

120		Q103.120.I	-
120		Q103.120.D	-
120		Q103.120.X	-
140		Q103.140.I	-
140		Q103.140.D	-
140		Q103.140.X	-
160		Q103.160.I	-
160		Q103.160.D	-
160		Q103.160.X	-
180		Q103.180.I	-
180		Q103.180.D	-
180		Q103.180.X	-
200		Q103.200.I	-
200		Q103.200.D	-
200		Q103.200.X	-



- Las composiciones asimétricas tienen la siguiente modulación: 120 (80+40), 140 (100+40), 160 (100+60), 180 (120+60), 200 (120+80). Otras configuraciones disponibles.
- Muebles especiales: Para medidas intermedias en anchura y/o altura tomar el precio de la medida inmediatamente superior. Fondo especial disponible de 39 a 45cm.
- El mueble de altura 27 no lleva sistema Decospace. Si la instalación lo permite se puede pedir sin sobreprecio.

- C Lavabo centrado
- D Lavabo derecho
- I Lavabo izquierdo
- X Lavabo doble



### BASES DE LAVABO SUSPENDIDAS

#### 2 CAJONES

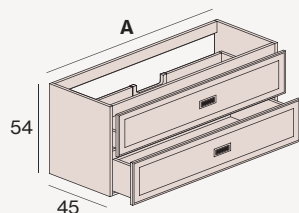

A (cm)	LAVABO	REF	PVP
60		Q201.060.C	-
70		Q201.070.C	-
80		Q201.080.C	-
90		Q201.090.C	-
100		Q201.100.I	-
100		Q201.100.C	-
100		Q201.100.D	-
120		Q201.120.I	-
120		Q201.120.C	-
120		Q201.120.D	-
120		Q201.120.X	-
140		Q201.140.I	-
140		Q201.140.C	-
140		Q201.140.D	-
140		Q201.140.X	-

#### 4 CAJONES ASIMÉTRICOS

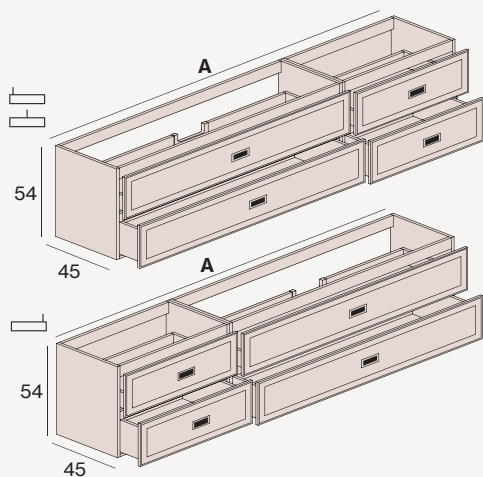

120		Q208.120.I	-
120		Q208.120.C	-
120		Q208.120.D	-
140		Q208.140.I	-
140		Q208.140.C	-
140		Q208.140.D	-
160		Q208.160.I	-
160		Q208.160.C	-
160		Q208.160.D	-
180		Q208.180.I	-
180		Q208.180.C	-
180		Q208.180.D	-
200		Q208.200.I	-
200		Q208.200.C	-
200		Q208.200.D	-

#### 4 CAJONES SIMÉTRICOS

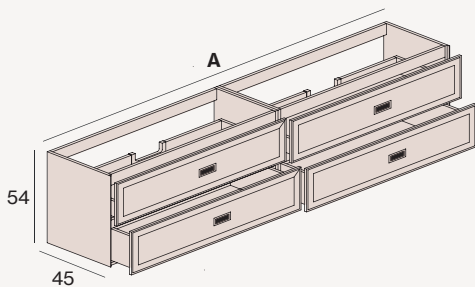

120		Q209.120.I	-
120		Q209.120.D	-
120		Q209.120.X	-
140		Q209.140.I	-
140		Q209.140.D	-
140		Q209.140.X	-
160		Q209.160.I	-
160		Q209.160.D	-
160		Q209.160.X	-
180		Q209.180.I	-
180		Q209.180.D	-
180		Q209.180.X	-
200		Q209.200.I	-
200		Q209.200.D	-
200		Q209.200.X	-

### Complementos

#### & complementa

COMPLEMENTA  
TU MUEBLE  
Organizadores, toalleros,...  
pág. 148

## BASES DE LAVABO SUSPENDIDAS

## 3 CAJONES

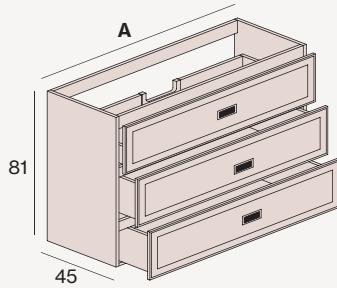

A (cm)	LAVABO	REF	PVP
60		Q213.060.C	-
70		Q213.070.C	-
80		Q213.080.C	-
90		Q213.090.C	-
100		Q213.100.I	-
100		Q213.100.C	-
100		Q213.100.D	-



- Las composiciones asimétricas tienen la siguiente modulación: 120 (80+40), 140 (100+40), 160 (100+60), 180 (120+60), 200 (120+80). Otras configuraciones disponibles.
- Muebles especiales: Para medidas intermedias en anchura y/o altura tomar el precio de la medida inmediatamente superior. Fondo especial disponible de 39 a 45cm.

- C Lavabo centrado
- D Lavabo derecho
- I Lavabo izquierdo
- X Lavabo doble

MÓDULOS SUSPENDIDOS

1 CAJÓN / BANCADA

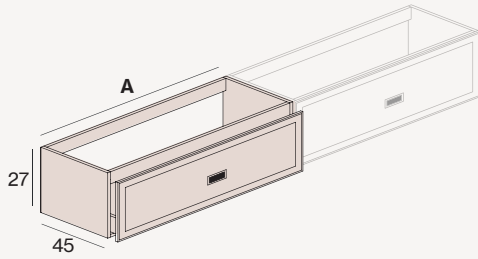

A (cm)	REF	TIRADOR	PVP
40	Q101.040.M	-	-
60	Q101.060.M	-	-
70	Q101.070.M	-	-
80	Q101.080.M	-	-
90	Q101.090.M	-	-
100	Q101.100.M	-	-
120	Q101.120.M	-	-
140	Q101.140.M	-	-

2 CAJONES

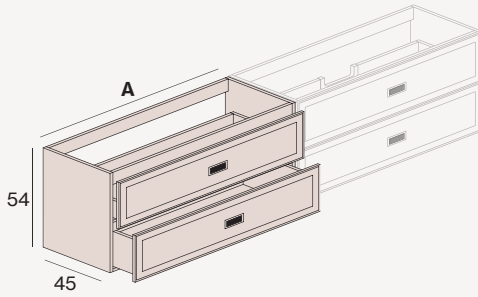

40	Q201.040.M	-	-
60	Q201.060.M	-	-
70	Q201.070.M	-	-
80	Q201.080.M	-	-
90	Q201.090.M	-	-
100	Q201.100.M	-	-
120	Q201.120.M	-	-
140	Q201.140.M	-	-

3 CAJONES

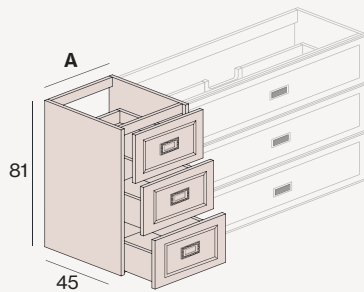

40	Q313.040.M	-	-
60	Q313.060.M	-	-
70	Q313.070.M	-	-
80	Q313.080.M	-	-
90	Q313.090.M	-	-
100	Q313.100.M	-	-



**& complementa**  
 COMPLEMENTA  
 TU MUEBLE  
 Organizadores, toalleros,...  
 pág. 148

· Puede crear su mueble personalizado añadiendo los módulos a derecha y/o izquierda de la base de lavabo seleccionada. Especifique la posición de los mismos.



# Alma by

Características y equipamiento	142
Personaliza tu mueble Alma	143
Bases de lavabo suspendidas	144
Módulos suspendidos	146
Complementos Atelier	148

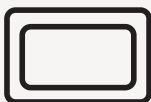

#### DECOSPACE SYSTEM

Sistema que incluye el suministro de un sifón ahorra espacio y una válvula clic clac cromo brillo. Con esta solución se evita el cajeado del cajón superior mejorando la capacidad de almacenamiento y estética interior ya que las instalaciones quedan ocultas.



#### ANTRACITA FULLCOLOR

Concepto de diseño interior por el que todos los materiales del interior de los muebles están diseñados en color antracita. Los muebles con acabado lacado se lacan interiormente en color antracita.



#### DECOFIX SYSTEM

Sistema de fijación a pared de alta seguridad con el que las resistencias de carga son superiores a 240 kg.



#### ATELIER SYSTEM

En los acabados de tablero marino o madera maciza se seleccionan las piezas de forma numerada para respetar la continuidad de la veta en todo el mueble.



#### CAJONES 4D

Cajones metálicos Hettich o Blum de color antracita y de perfil extrafino de 12 mm con 4 regulaciones de ajuste. Las guías son de extracción total y sistema de frenado progresivo.



#### DURALACK SYSTEM

Los colores lacados llevan unos aditivos endurecedores que permiten que el acabado final sea muy resistente al frote y a la abrasión.



#### DECOBUILD SYSTEM

Los muebles fabricados con tableros de 19 mm están encolados entre sí con clavillas consiguiendo una estética limpia sin herrajes visibles y ofreciendo mejor resistencia y durabilidad.



#### A MEDIDA

Esta colección permite su fabricación a medida. En el caso de medidas intermedias de altura y anchura tomar el precio de la medida inmediatamente superior.



#### PUSH AND SLOW

Los cajones con sistema de apertura Push sin tirador llevan un sistema de sincronización que permite su apertura haciendo presión en cualquier punto del frontal. A su vez el cierre es progresivo y silencioso.



#### WOOD PROTECT SYSTEM

Las maderas tablero marino o madera maciza están protegidas contra los agentes externos con aceites naturales que respetan la textura y naturaleza de la Massello.

## Configura y personaliza tu mueble Alma

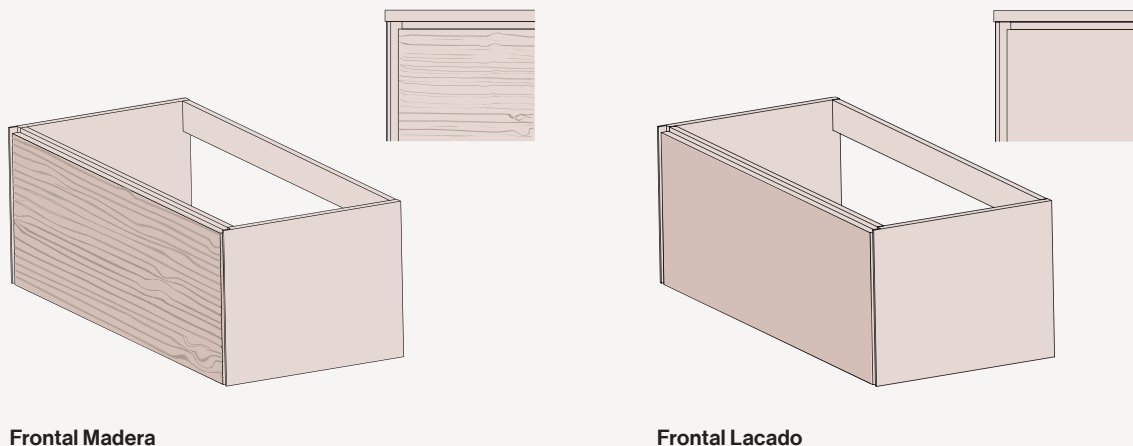

Frontal Madera

Frontal Lacado

### A Escoge el color de la estructura del mueble

#### Lacados



### B Escoge el color del frontal PUSH

#### Lacados



#### Madera Tablero Marino / Chapa de Roble y Nogal

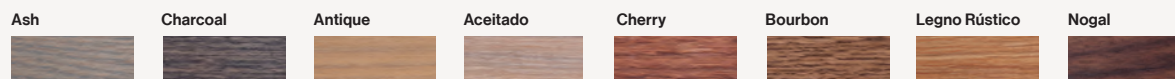

#### Madera Maciza / Roble



## BASES DE LAVABO SUSPENDIDAS

## 1 CAJÓN

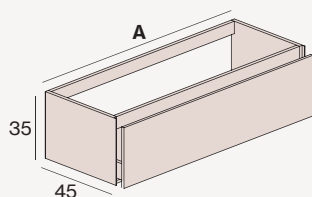

A (cm)	LAVABO	REF	LACA	MADERA TABLERO MARINO	MADERA MACIZA
(solo frontal, estructura lacada)					
60		A101.060.C	-	-	-
70		A101.070.C	-	-	-
80		A101.080.C	-	-	-
90		A101.090.C	-	-	-
100		A101.100.I	-	-	-
100		A101.100.C	-	-	-
100		A101.100.D	-	-	-
120		A101.120.I	-	-	-
120		A101.120.C	-	-	-
120		A101.120.D	-	-	-
120		A101.120.X	-	-	-
140		A101.140.I	-	-	-
140		A101.140.C	-	-	-
140		A101.140.D	-	-	-
140		A101.140.X	-	-	-

## 2 CAJONES ASIMÉTRICOS

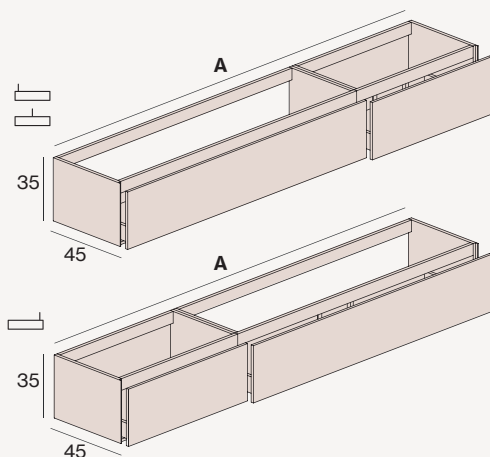

120		A102.120.I	-	-	-
120		A102.120.C	-	-	-
120		A102.120.D	-	-	-
140		A102.140.I	-	-	-
140		A102.140.C	-	-	-
140		A102.140.D	-	-	-
160		A102.160.I	-	-	-
160		A102.160.C	-	-	-
160		A102.160.D	-	-	-
180		A102.180.I	-	-	-
180		A102.180.C	-	-	-
180		A102.180.D	-	-	-
200		A102.200.I	-	-	-
200		A102.200.C	-	-	-
200		A102.200.D	-	-	-

## 2 CAJONES SIMÉTRICOS

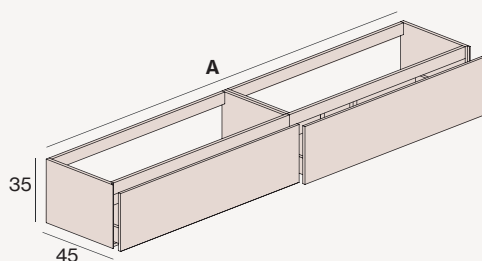

120		A103.120.I	-	-	-
120		A103.120.D	-	-	-
120		A103.120.X	-	-	-
140		A103.140.I	-	-	-
140		A103.140.D	-	-	-
140		A103.140.X	-	-	-
160		A103.160.I	-	-	-
160		A103.160.D	-	-	-
160		A103.160.X	-	-	-
180		A103.180.I	-	-	-
180		A103.180.D	-	-	-
180		A103.180.X	-	-	-
200		A103.200.I	-	-	-
200		A103.200.D	-	-	-
200		A103.200.X	-	-	-



- Las composiciones asimétricas tienen la siguiente modulación: 120 (80+40), 140 (100+40), 160 (100+60), 180 (120+60), 200 (120+80). Otras configuraciones disponibles.
- Muebles especiales: Para medidas intermedias en anchura y/o altura tomar el precio de la medida inmediatamente superior.
- El mueble de altura 35 no lleva sistema Decospace. Si la instalación lo permite se puede pedir sin sobreprecio.

**& complementa**

COMPLEMENTA  
TU MUEBLE  
Organizadores, toalleros,...  
pág. 148

- C Lavabo centrado
- D Lavabo derecho
- I Lavabo izquierdo
- X Lavabo doble



BASES DE LAVABO SUSPENDIDAS

2 CAJONES

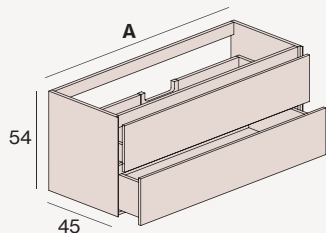

A (cm)	LAVABO	REF	LACA	MADERA TABLERO MARINO	MADERA MACIZA
(solo frontal, estructura lacada)					
60		A202.060.C	-	-	-
70		A202.070.C	-	-	-
80		A202.080.C	-	-	-
90		A202.090.C	-	-	-
100		A202.100.I	-	-	-
100		A202.100.C	-	-	-
100		A202.100.D	-	-	-
120		A202.120.I	-	-	-
120		A202.120.C	-	-	-
120		A202.120.D	-	-	-
120		A202.120.X	-	-	-
140		A202.140.I	-	-	-
140		A202.140.C	-	-	-
140		A202.140.D	-	-	-
140		A202.140.X	-	-	-

1 CAJÓN + DECORATIVO

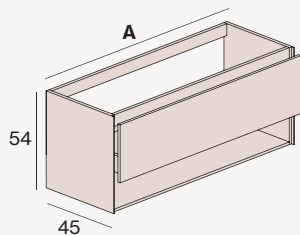

60		A203.060.C	-	-	-
70		A203.070.C	-	-	-
80		A203.080.C	-	-	-
90		A203.090.C	-	-	-
100		A203.100.I	-	-	-
100		A203.100.C	-	-	-
100		A203.100.D	-	-	-
120		A203.120.I	-	-	-
120		A203.120.C	-	-	-
120		A203.120.D	-	-	-
120		A203.120.X	-	-	-
140		A203.140.I	-	-	-
140		A203.140.C	-	-	-
140		A203.140.D	-	-	-
140		A203.140.X	-	-	-

4 CAJONES ASIMÉTRICOS

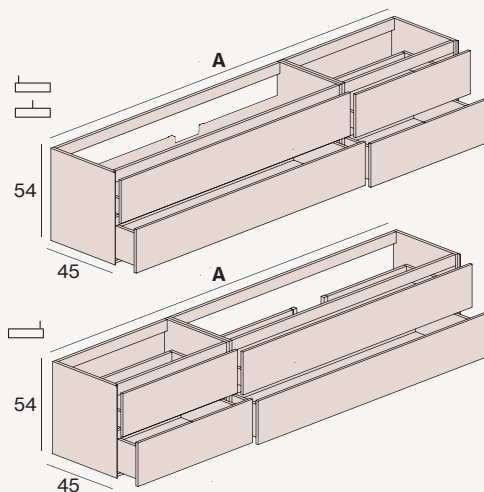

120		A208.120.I	-	-	-
120		A208.120.C	-	-	-
120		A208.120.D	-	-	-
140		A208.140.I	-	-	-
140		A208.140.C	-	-	-
140		A208.140.D	-	-	-
160		A208.160.I	-	-	-
160		A208.160.C	-	-	-
160		A208.160.D	-	-	-
180		A208.180.I	-	-	-
180		A208.180.C	-	-	-
180		A208.180.D	-	-	-
200		A208.200.I	-	-	-
200		A208.200.C	-	-	-
200		A208.200.D	-	-	-



**& complementa**  
COMPLEMENTA  
TU MUEBLE  
Organizadores, toalleros,...  
pág. 148

- C Lavabo centrado
- D Lavabo derecho
- I Lavabo izquierdo
- X Lavabo doble

**BASES DE LAVABO SUSPENDIDAS**

**4 CAJONES SIMÉTRICOS**

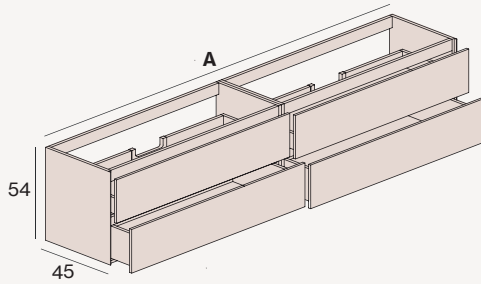

A (cm)	LAVABO	REF	LACA	MADERA TABLERO MARINO	MADERA MACIZA
(solo frontal, estructura lacada)					
120		A209.120.I	-	-	-
120		A209.120.D	-	-	-
120		A209.120.X	-	-	-
140		A209.140.I	-	-	-
140		A209.140.D	-	-	-
140		A209.140.X	-	-	-
160		A209.160.I	-	-	-
160		A209.160.D	-	-	-
160		A209.160.X	-	-	-
180		A209.180.I	-	-	-
180		A209.180.D	-	-	-
180		A209.180.X	-	-	-
200		A209.200.I	-	-	-
200		A209.200.D	-	-	-
200		A209.200.X	-	-	-

**MÓDULOS SUSPENDIDOS**

**1 CAJÓN / BANCADA**

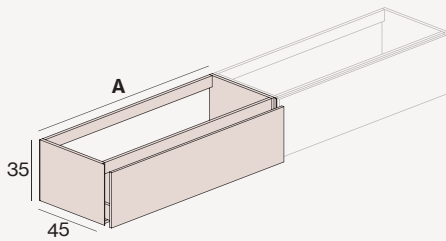

A (cm)	REF	LACA	MADERA TABLERO MARINO	MADERA MACIZA
(solo frontal, estructura lacada)				
30	A101.030.M	-	-	-
40	A101.040.M	-	-	-
60	A101.060.M	-	-	-
70	A101.070.M	-	-	-
80	A101.080.M	-	-	-
90	A101.090.M	-	-	-
100	A101.100.M	-	-	-
120	A101.120.M	-	-	-
140	A101.140.M	-	-	-

**2 CAJONES / BANCADA**

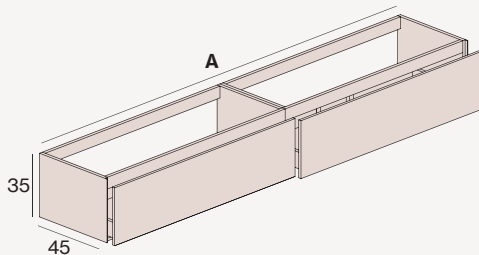

120	A103.120.M	-	-	-
140	A103.140.M	-	-	-
160	A103.160.M	-	-	-
180	A103.180.M	-	-	-
200	A103.200.M	-	-	-



· Puede crear su mueble personalizado añadiendo los módulos a derecha y/o izquierda de la base de lavabo seleccionada. Especifique la posición de los mismos.

**& complementa**  
 COMPLEMENTA  
 TU MUEBLE  
 Organizadores, toalleros,...  
 pág. 148

- C Lavabo centrado
- D Lavabo derecho
- I Lavabo izquierdo
- X Lavabo doble

## MÓDULOS SUSPENDIDOS

## DECORATIVO

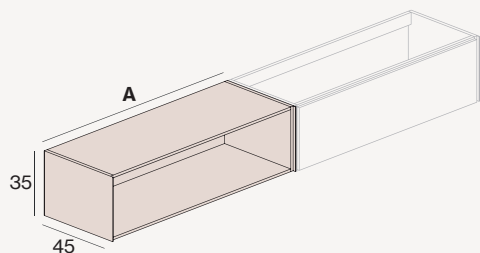

A (cm)	REF	LACA
30	A104.030.M	-
40	A104.040.M	-
60	A104.060.M	-
70	A104.070.M	-
80	A104.080.M	-

## DECORATIVO 2 ESTANTES

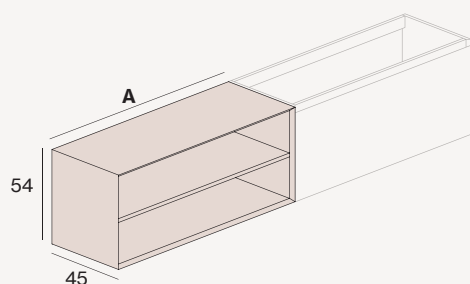

30	A207.030.M	-
40	A207.040.M	-
60	A207.060.M	-
70	A207.070.M	-
80	A207.080.M	-

## 2 CAJONES

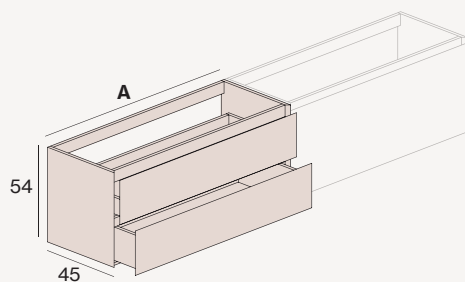

A (cm)	REF	LACA	MADERA TABLERO MARINO	MADERA MACIZA
<small>(solo frontal, estructura lacada)</small>				
30	A201.030.M	-	-	-
40	A201.040.M	-	-	-
60	A201.060.M	-	-	-
70	A201.070.M	-	-	-
80	A201.080.M	-	-	-
90	A201.090.M	-	-	-
100	A201.100.M	-	-	-
120	A201.120.M	-	-	-
140	A201.140.M	-	-	-

## 1 CAJÓN + DECORATIVO

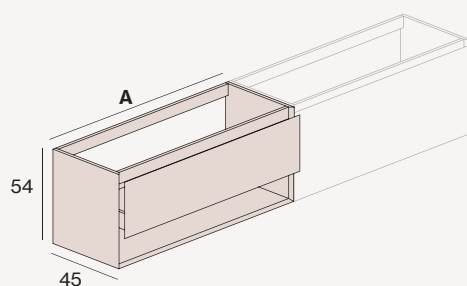

30	A203.030.M	-	-	-
40	A203.040.M	-	-	-
60	A203.060.M	-	-	-
70	A203.070.M	-	-	-
80	A203.080.M	-	-	-
90	A203.090.M	-	-	-
100	A203.100.M	-	-	-
120	A203.120.M	-	-	-
140	A203.140.M	-	-	-



· Puede crear su mueble personalizado añadiendo los módulos a derecha y/o izquierda de la base de lavabo seleccionada. Especifique la posición de los mismos.

**& complementa**

COMPLEMENTA  
TU MUEBLE  
Organizadores, toalleros, ...  
pág. 148



# Complementos para muebles de baño **Atelier**

Interior mueble	150
Patas mueble	151
Exterior mueble	152

### INTERIOR MUEBLE

#### ORGADRAW

Set de organizadores.



Antracita



REF

PVP

CM1

-

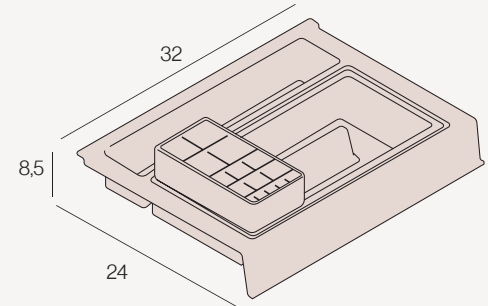

#### ORGASTRIP

Sistema de separadores guiados por riles para cajón superior.

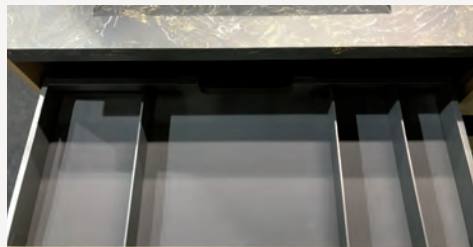

Antracita

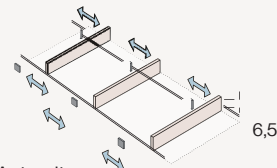

A	REF	SEPARADORES	PVP
---	-----	-------------	-----

30	CM2.030	1	-
40	CM2.040	1	-
60	CM2.060	2	-
70	CM2.070	2	-
80	CM2.080	3	-
90	CM2.090	3	-
100	CM2.100	4	-
120	CM2.120	4	-
140	CM2.140	4	-

#### Separador adicional

CM2.010	1	-
---------	---	---

#### PROTECCIÓN CAJÓN

Lámina protectora antideslizante para cajón.



Colores

Perla



Teja



A	PERLA		TEJA	
	REF	PVP	REF	PVP

30	CM3.030	-	CM4.030	-
40	CM3.040	-	CM4.040	-
60	CM3.060	-	CM4.060	-
70	CM3.070	-	CM4.070	-
80	CM3.080	-	CM4.080	-
90	CM3.090	-	CM4.090	-
100	CM3.100	-	CM4.100	-
120	CM3.120	-	CM4.120	-
140	CM3.140	-	CM4.140	-

### PATAS DE MUEBLE

#### ESTRUCTURA METAL PARA MUEBLE H54

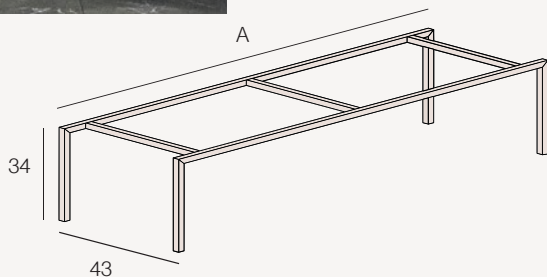

A	REF	NEGRO	COLOR
60	CM5.060	-	-
70	CM5.070	-	-
80	CM5.080	-	-
90	CM5.090	-	-
100	CM5.100	-	-
120	CM5.120	-	-
140	CM5.140	-	-
160	CM5.160	-	-
180	CM5.180	-	-
200	CM5.200	-	-

La medida del fondo de la estructura es aproximadamente 2 centímetros inferior respecto al fondo del mueble para no interferir con los frontales.

#### Colores



#### PATASH3

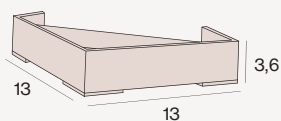

Cromo  
brillo

#### REF

#### PVP

CM6

-

Juego de 4 unidades

#### PATASH7

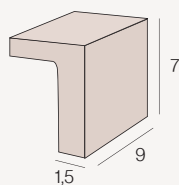

Cromo  
brillo

#### REF

#### PVP

CM7

-

Juego de 4 unidades

### EXTERIOR MUEBLE

#### TOALLERO LATERAL

Toallero cromo brillo para colocar en el lateral del mueble.

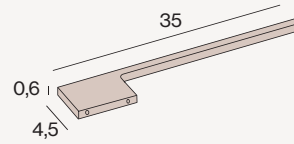
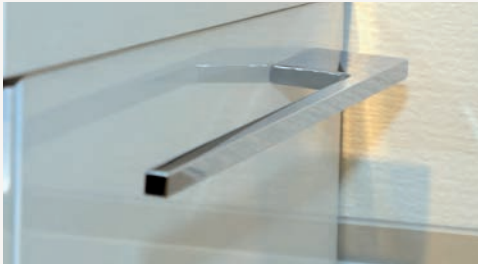

COLOR	REF	PVP
-------	-----	-----

Cromo brillo	CM8.CB	-
Negro mate	CM8.BK	-
Color (carta laca)	CM8.CO	-

#### Colores



#### TOALLERO DE PIE

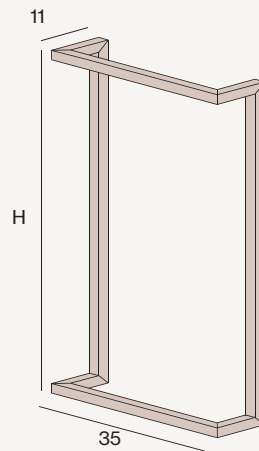

H	COLOR	REF	PVP
---	-------	-----	-----

75	Negro mate	CM9.75.BK	-
75	Color (carta laca)	CM9.75.CO	-
85	Negro mate	CM9.85.BK	-
85	Color (carta laca)	CM9.85.CO	-

H = 85 cm para mueble con lavabo integrado.

H = 75 cm para mueble con lavabo sobreencimera.

#### Colores





### EXTERIOR MUEBLE

#### RETROILUMINACIÓN INFERIOR MUEBLE

Iluminación debajo del mueble, debajo de encimera mural, armario de colgar o columna.

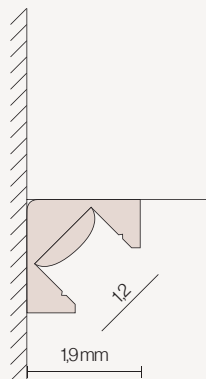

A	REF	PVP
60	CM10.060	-
70	CM10.070	-
80	CM10.080	-
90	CM10.090	-
100	CM10.100	-
120	CM10.120	-
140	CM10.140	-
160	CM10.160	-
180	CM10.180	-
200	CM10.200	-

La medida real de la iluminación LED es 4 centímetros inferior respecto al ancho del mueble para que no se vea desde el lateral.

LUZ	COLOR °K	CONSUMO	POTENCIA	ESTANQUEIDAD	DRIVER	MATERIAL
LED	4000°K Neutra	4,8W	400 LUMENS metro lineal	IP67	INCLUIDO	ALUMINIO

Personaliza tu LED en 3000°K ó 4200°K sin extra de precio. Standard de 5500°K.

#### REGLETA AJUSTE PAREDES

Regleta de ajuste entre paredes.



H	REF	LACA	MADERA TABLERO MARINO
27	CM15.27	-	-
35	CM15.35	-	-
54	CM15.54	-	-
81	CM15.81	-	-

X a definir según necesidad.



# 02 Casual Muebles de baño

La tendencia, la frescura, lo cotidiano.

# Play

Libertad de componer, modular,  
colorear cada proyecto.





▲ Bañera  
*Orion Solid Surface*

Auxiliar  
*Estantería metálica  
doble estante*





Mueble  
2 baúles más cajón  
interior / Frontal  
tirador Glass



Encimera  
Integrada con faldón  
Negro Marquina



Espejo enmarcado  
Metalsquare con espejo  
aumento móvil



Luz decorativa  
Ledarc



PLAY



◀ Detalle frontal glass con perfil metálico y tirador integrado con cristal texturado en color de la carta de lacados





Espejo enmarcado  
*Metalsquare*

Luz colgante  
*Ledarc*



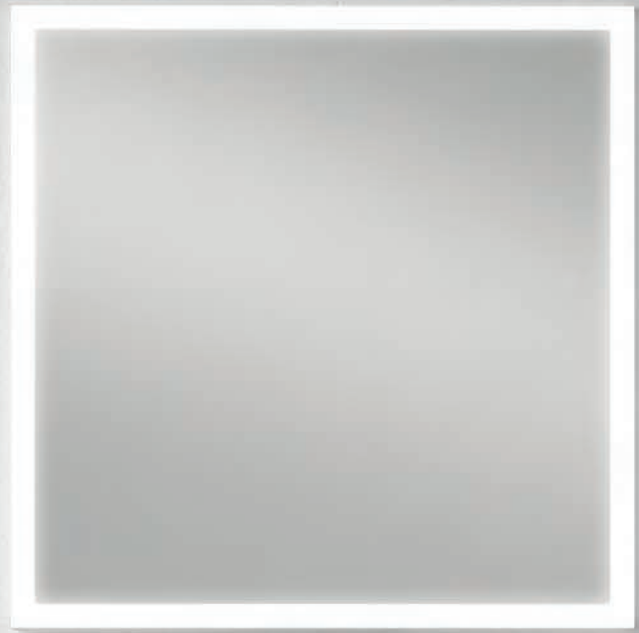



◀ Mueble  
*1 baúl con cajón  
interior / frontal glass*



239

Encimera  
*Plana Ceramcolor  
Lavabo Ceramcolor  
Circus*



290

Espejo  
retroiluminado  
*Fronled*



304

Auxiliar  
*Banqueta metálica  
con sobre lacado*



335





▲ Lavabo cerámico coloreado con el mismo color del mueble disponible hasta en 8 colores

◀ Mueble frontal glass texturado lacado del mismo color que el mueble en los 18 colores disponibles

▼ Banqueta auxiliar







- ◀ Mueble  241

*4 cajones / tirador Incolor*

*acabado lacado*

*Estructura metálica*

*de patas decorativa*
- Encimera  289

*Plana Solid Surface*

*Lavabo Solid*

*Surface Cuadro*
- Espejo enmarcado  308

*Corner a medida*
- Luz decorativa  321

*Ledcirc*
- Auxiliar  331

*Armario auxiliar dos puertas*

*y decorativo*
- Bañera  338

*Borealis Solid Surface*

Detalle interior del mueble. Cajones ▶  
metálicos 4D de extracción total y  
frenado silencioso. El cajón superior  
del lavabo con sifón distribuidor

▼ Espejo Corner ingletado lacado









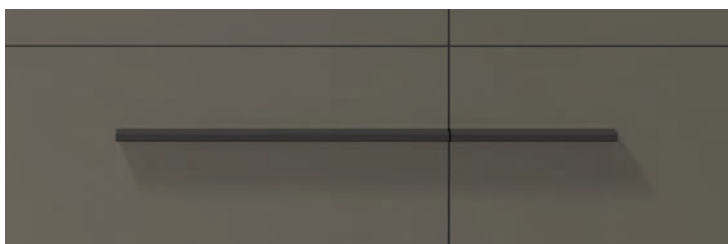
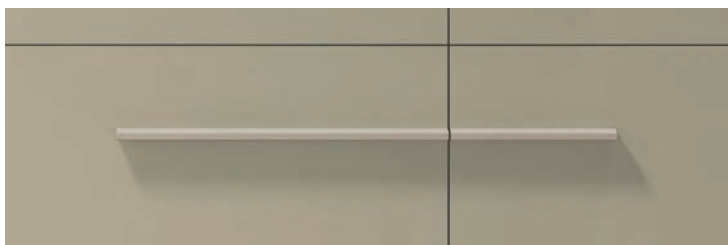
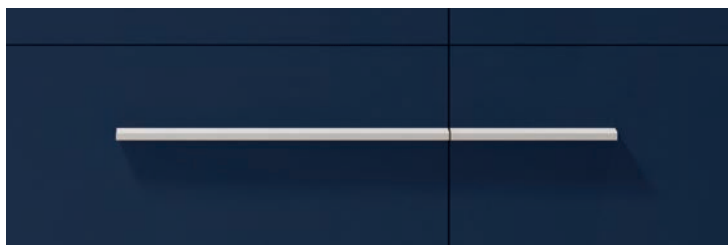
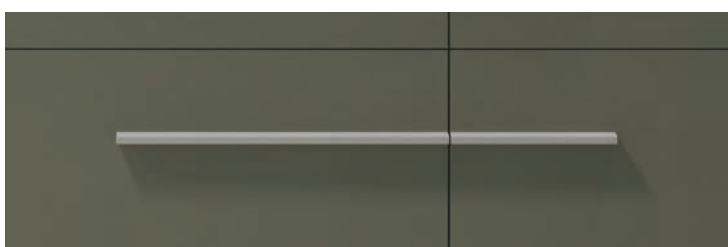





◀ Personaliza tu mueble con tirador Incolor con cualquiera de los 18 colores de la carta de lacados. Elije el color tanto en el mueble como en el tirador de aluminio lacado epoxi





- ◀ Mueble  
*2 cajones + hueco decorativo /  
tirador Incolor*  241
  
- Encimera  
*Plana Solid Mineral  
Lavabo sobreencimera Smile*  288
  
- Especo liso  
*Round liso*  300
  
- Auxiliar  
*Estante madera Complet  
toallero metálico pared*  332  
 334



239

Mueble frontal ▶  
*2 cajones lacado /  
tirador Black*  
*Toallero metálico de pie*



306

Espejo enmarcado  
*Metalsquareled*



321

Luz decorativa  
*Ledcirc*



330

Auxiliares



335

*Armario 2 puertas vitrina /  
Banqueta auxiliar*

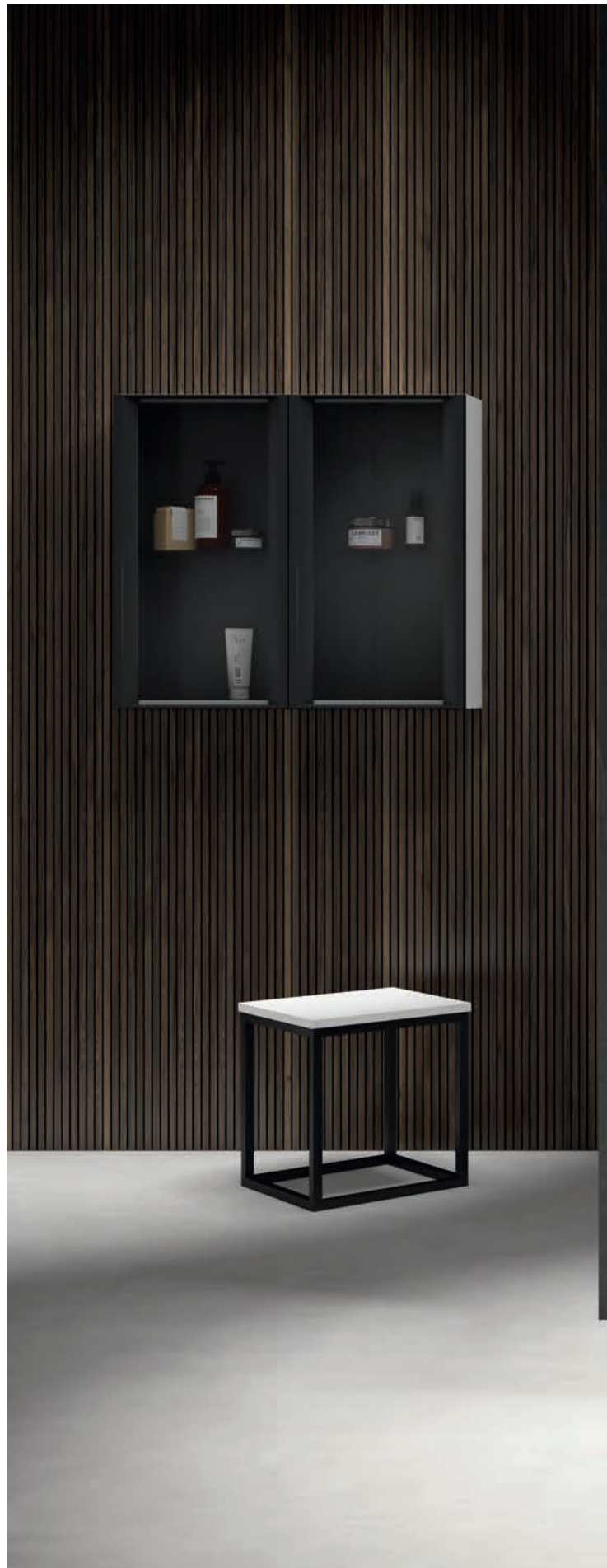



244-245

Mueble  
Módulo 2 cajones y módulo 1 cajón con  
encimera Madera Nature/ tirador Black

284

Encimera  
Plana con faldón Madera Nature  
lavabo Ceramcolor Circus

277

306

Espejo enmarcado  
Metalrounded







320

Luz decorativa  
*Ledpoint*



332

Auxiliar  
*Estante decorativo Complet*



339

Bañera  
*Orion Solid Surface*





▲ Detalle tirador black



◀ Luz decorativa  
*Ledpoint*

Auxiliar  
*Estante decorativo*  
*Complet*



▲ Espejos enmarcados de metal  
con led integrado





▲ Auxiliar  
*Columna decorativa*



329



Mueble  
2 cajones lacado / tirador Curve  
Módulo lateral decorativo



Encimera integrada  
Mural Pizarra



Espejo  
Eyeled



Auxiliar  
Armario auxiliar con  
decorativo 2 puertas





◀ Espejo retroiluminación frontal Eyeled



▲ Detalle módulo decorativo lateral

 338

Bañera ▶  
*Leo Solid Surface*







Mueble  
2 cajones y mueble de 1 cajón con hueco  
decorativo / tirador Lineal lacado



Encimera  
Plana roble macizo  
lavabo sobreencimera Copa



Espejo retroiluminado ▲  
Circled





▲ Encimera plana roble macizo



▲ Detalle tirador fresado Lineal

238

Mueble ▶

*Bancada 2 cajones  
lacado / tirador Inglete*

268

Encimeras  
*Mural integrada  
Solid Mineral a medida /  
Tapa plana Solid Mineral  
a medida*

302

Espejo retroiluminado  
*Filed*

321

Luz decorativa  
*Circled*

328

Auxiliar  
*Columna dos  
puertas lacadas*





02 CASUAL  
MUEBLES DE BAÑO

Auxiliares ▶  
*Columna 2 puertas / tirador Push /  
banqueta auxiliar*

Bañera  
*Leo Solid Surface*







▲ Detalle tirador inglete 45°









- ◀ **Mueble**  
*1 cajón / estructura lateral  
lacada y frontal Madera  
Nature / tirador Rail /  
toallero lateral lacado*  238
  
- Encimera Integrada**  
*Solid Mineral standard*  264
  
- Espejo**  
*Liso con aumento LED 5X*  300-310
  
- Auxiliar**  
*Toallero de pared  
lacado*  334
  
- Iluminación**  
*Aplique para espejo Ledin*  318



- ▲ Bañera  
*Borealis Solid Surface*
- Luz decorativa  
*Ledpoint*





Mueble  
2 cajones y 1 puerta / estructura  
lateral Madera Nature y frontal  
lacado / tirador Neo



Encimera integrada  
Solid Mineral  
desplazada izquierda



Espejo retroiluminado  
Circled



Auxiliar  
Armario 1 puerta  
toallero de pie  
independiente





◀ Toallero de suelo metálico. Disponible en colores lacados



◀ Detalle cajón superior con distribuidor



◀ Detalle tirador Neo



239



243



284



300



328



339



319

### Mueble ▶

*2 cajones + estructura metálica  
Madera Nature / tirador Push*

### Encimera

*Plana Madera Nature  
lavabo sobreencimera  
Ceramcolor*

### Espejo

*Liso securizado a medida*

### Auxiliares

*Composición formada por  
columna de 2 puertas y  
columna de 1 puerta lacada*

### Bañera

*Leo Solid Surface*

### Iluminación

*Aplique para espejo Ledbar*











- ▲ Se pueden personalizar las estructuras metálicas en cualquiera de los colores de la carta de lacados

Mueble  
2 Baúles / tirador Line

Encimera plana  
Lacada / lavabo Solid Surface

Espejo Retroiluminado  
Spined





332



334

Auxiliar  
*Estante decorativo Complet*  
*Toallero metálico pared*  
*Armario 2 puertas lacado*  
*Estantería metálica doble estante*



339

Bañera  
*Leo Solid Surface*



328



334







- ◀ Mueble 📄 242  
*1 cajón y 1 baúl / tirador*  
*Line acabado lacado*
  
- Encimera plana 📄 288  
*Solid Mineral*
  
- Lavabo 📄 283  
*Tótem Solid Surface*
  
- Espejo retroiluminado 📄 303  
*Spinled*



◀ Mueble  
*1 cajón y 1 baúl / tirador Line  
acabado lacado*

Encimera  
*Plana Solid mineral*

Lavabo ▶  
*Tótem Solid Surface*  
Espejo retroiluminado  
*Spinled*





▲ Mueble  
 1 cajón / tirador Frame acabado lacado  
 Estructura metálica de patas decorativas  
 con estante cristal fumé

 238

 243

Encimera integrada  
 Solid Mineral

 264

Espejo liso  
 Espejo con aplique Ledbar

 300

 319





Luz decorativa  
*Ledcirc*



Bañera  
*Leo Solid Surface*



Bañera ▶  
*Leo Solid Surface*  
Luz decorativa  
*Ledcirc*

▼ Detalle frontal frame



▲ Estructura  
*Detalle estructura metálica con cristal fumé*





▲ Mueble  
*Estructura metálica de patas  
con estante en cristal fumé  
y toallero*

Encimera integrada  
*Solid Mineral Thin*

Espejo retroiluminado  
*Rounded*



▲ Bañera  
*Borealis Solid Surface*

Auxiliar  
*Toallero metálico de pie*



PLAY

# Step

Lo concreto, justo a tiempo.



Bañera  
▼ *Borealis Solid Surface*

Auxiliar  
*Toallero metálico pared*







Mueble  
2 cajones / tirador Inglete  
Step acabado lacado



Encimera Integrada  
Cerámica



Espejo retroiluminado  
Rounded



Detalle frontal ►  
Inglete







256

Mueble ▶

2 cajones / tirador Step  
acabado laminado Sand



264

Encimera Integrada  
Solid Mineral



303

Espejo retroiluminado  
Spinled



335

Auxiliar  
Toallero metálico de pie  
independiente



338

Bañera  
Andrómeda Solid Surface







▲ Detalle textura laminado colección Step





▲ Mueble  
2 cajones / tirador Inglete  
Step acabado lacado Blanco Mate

Encimera Integrada  
Solid Mineral Hard de dos  
senos

Espejo liso  
Liso / aplique Ledin







Auxiliar  
*Toallero metálico pared*

Auxiliar ▶  
*Toallero metálico pared*





▲ Detalle interior cajones



STEP



# 02

## Información técnica y tarifa

# Casual

DECOSAN

Bath design

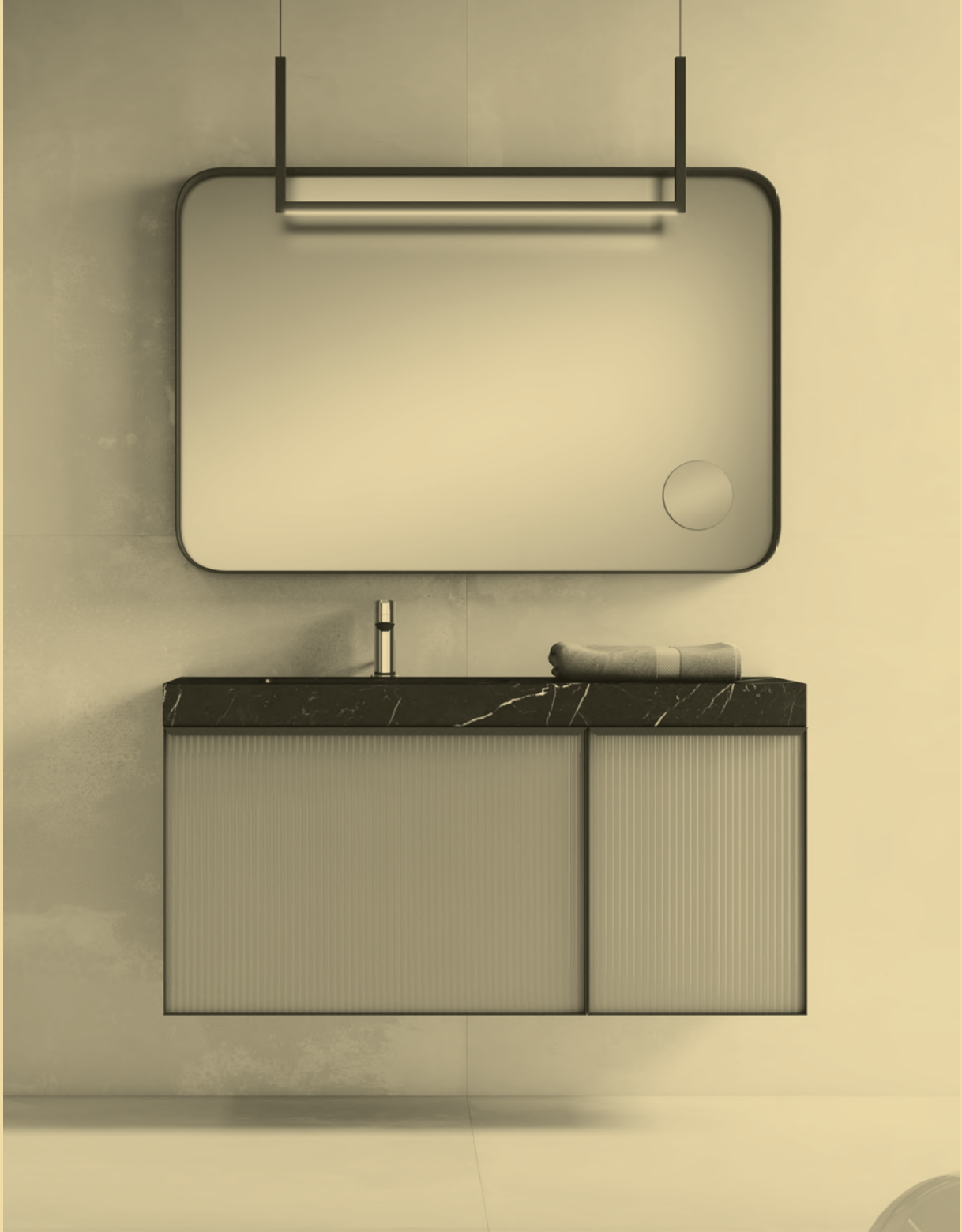

# Play

Características y equipamiento	232
Personaliza tu mueble Play	233
Bases de lavabo suspendidas	238
Módulos suspendidos	244
Play - Complementa	248



**CAJONES 4D**

Cajones metálicos Hettich o Blum de color antracita y de perfil extrafino de 12 mm con 4 regulaciones de ajuste. Las guías son de extracción total y sistema de frenado progresivo.



**A MEDIDA**

Esta colección permite su fabricación a medida. En el caso de medidas intermedias de altura y anchura tomar el precio de la medida inmediatamente superior.



**ANTRACITA FULLCOLOR**

Concepto de diseño interior por el que todos los materiales del interior de los muebles están diseñados en color antracita. Los muebles con acabado lacado se lacan interiormente en color antracita.



**DURALACK SYSTEM**

Los colores lacados llevan unos aditivos endurecedores que permiten que el acabado final sea muy resistente al frote y a la abrasión.



**PUSH AND SLOW**

Los cajones con sistema de apertura Push sin tirador llevan un sistema de sincronización que permite su apertura haciendo presión en cualquier punto del frontal. A su vez el cierre es progresivo y silencioso.



**DECOFIX SYSTEM**

Sistema de fijación a pared de alta seguridad con el que las resistencias de carga son superiores a 240 kg.



**DECOBUILD SYSTEM**

Los muebles fabricados con tableros de 19 mm están encolados entre sí con clavillas consiguiendo una estética limpia sin herrajes visibles y ofreciendo mejor resistencia y durabilidad.



## Play te lo pone fácil para personalizar tu mueble

Escoge el tirador, el color y la estructura del mueble en solo dos pasos

- 1 Escoge tu tirador y especifica el color deseado
  - 1.1 Tiradores lacados
  - 1.2 Tiradores Madera Nature
- 2 Escoge la estructura del mueble

**1.1** Escoge tu tirador Acabado lacado

**Black**

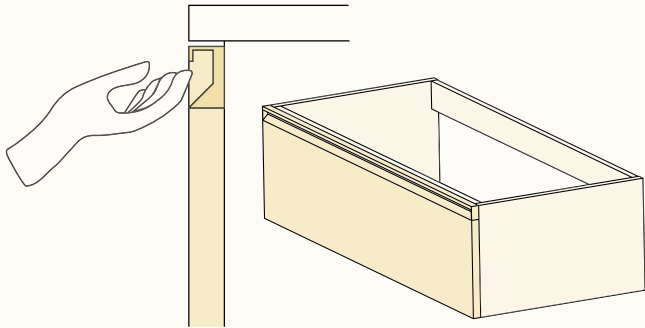

**Curve**

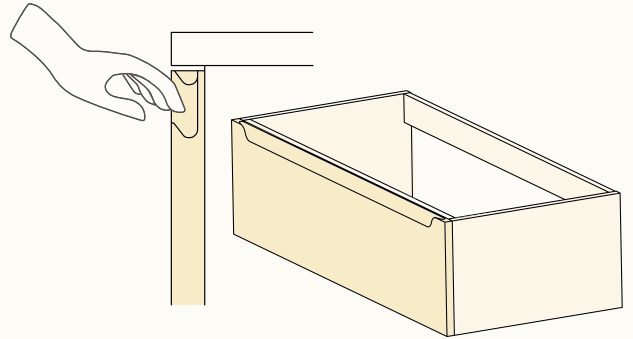

**Incolor**

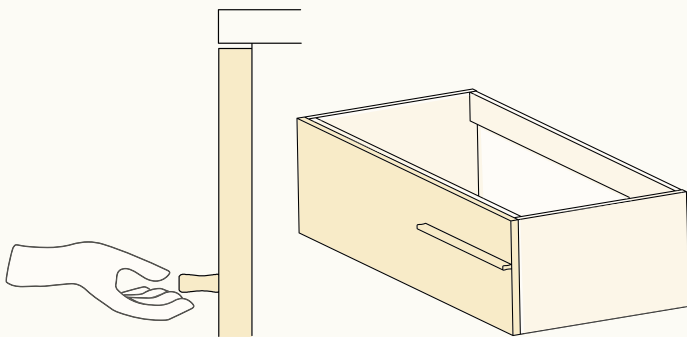

**Lineal**

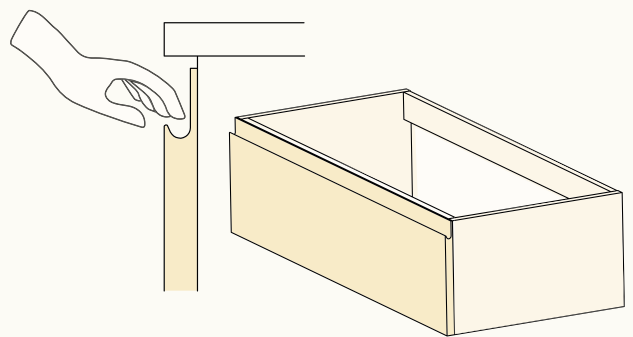

Se puede escoger el color del tirador diferente al del mueble

**Inglete**

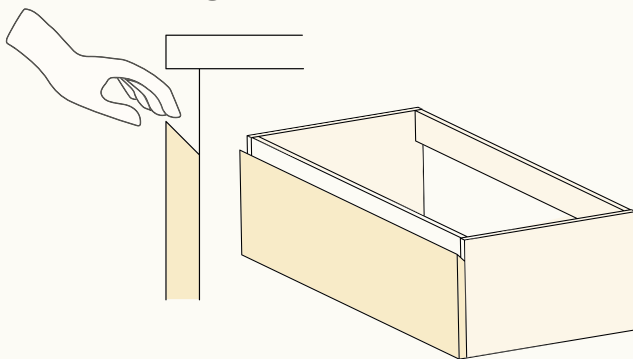

**Rail**

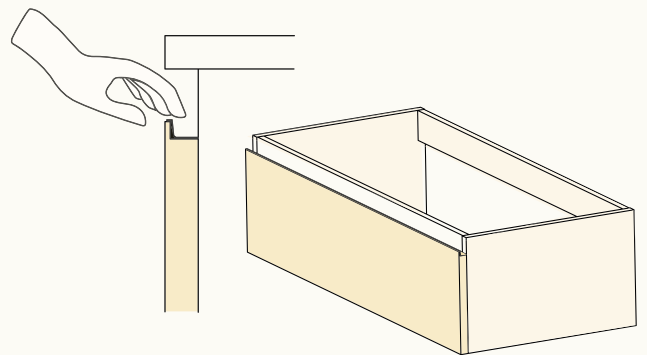

Perfil metálico aluminio satinado

Blanco Mate Blanco Brillo	Negro Mate Negro Brillo	Beige Mate Beige Brillo	Tierra Mate Tierra Brillo	Caqui Mate Caqui Brillo	Cuarzo Mate Cuarzo Brillo	Moka Mate Moka Brillo	Perla Mate Perla Brillo	Piedra Mate Piedra Brillo

**Neo**

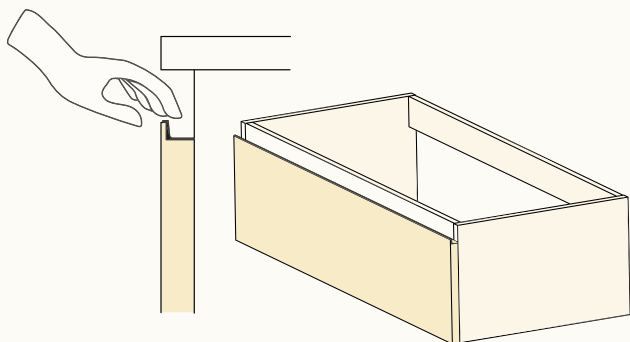

Perfil metálico negro mate

**Push**

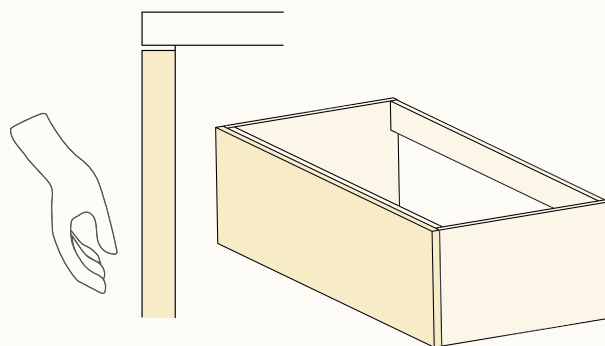

**Line**

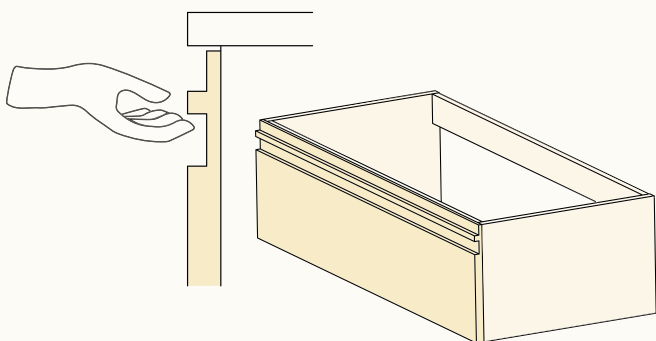

**Frame**

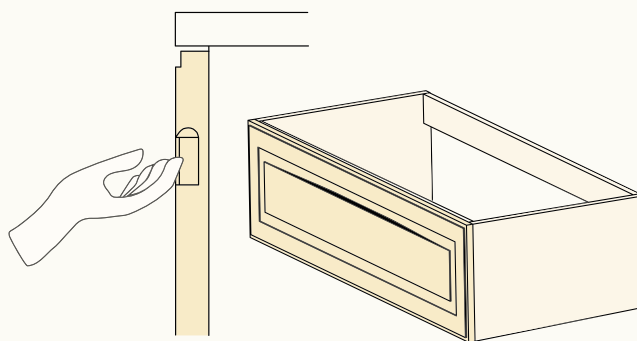

**Glass**

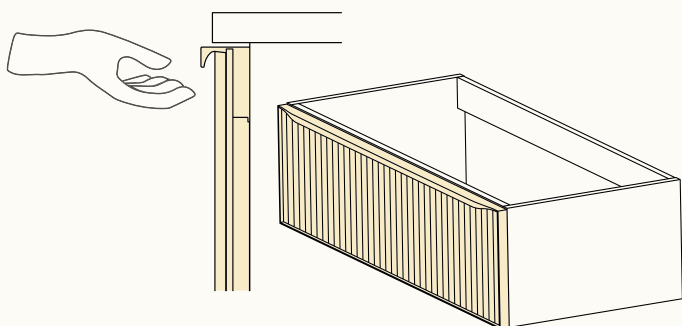

Perfil negro  
Se puede escoger el color del cristal diferente al del mueble



Color RAL ó NCS

RAL / NCS Mate

RAL / NCS Brillo

Acero Mate  
Acero Brillo

Antracita Mate  
Antracita Brillo

Burdeos Mate  
Burdeos Brillo

Océano Mate  
Océano Brillo

Menta Mate  
Menta Brillo

Oliva Mate  
Oliva Brillo

Terracota Mate  
Terracota Brillo

Albero Mate  
Albero Brillo

Rosa Mate  
Rosa Brillo



**1.2** Escoge tu tirador Acabado Madera Nature

**Black**

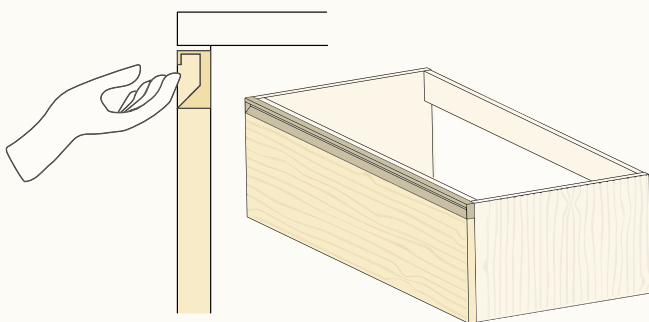

**Push**

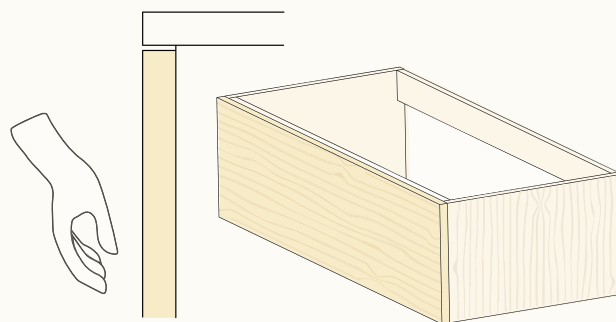

**Incolor**

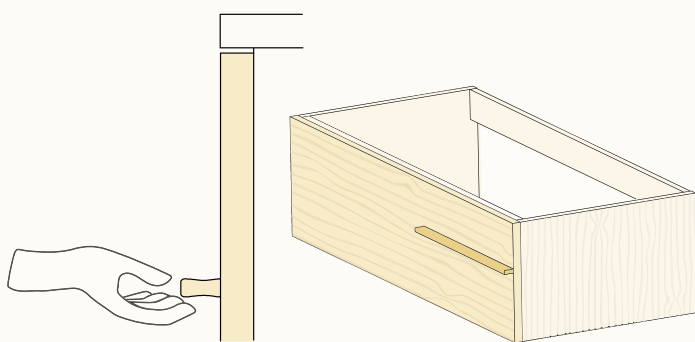

**Rail**

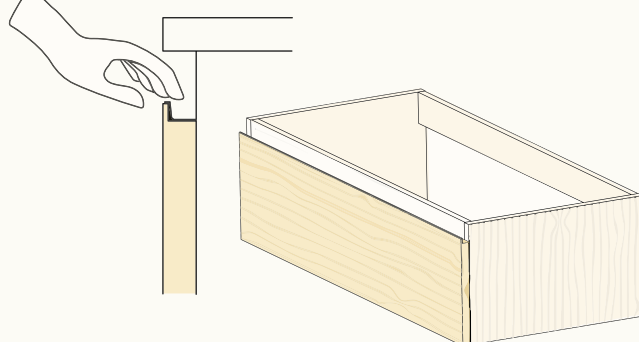

Escoge el color del tirador (lacado brillo o mate)

Perfil metálico aluminio satinado

**Neo**

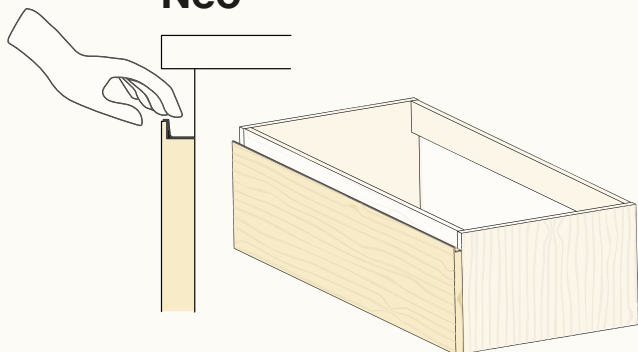

Perfil metálico negro mate

**Glass**

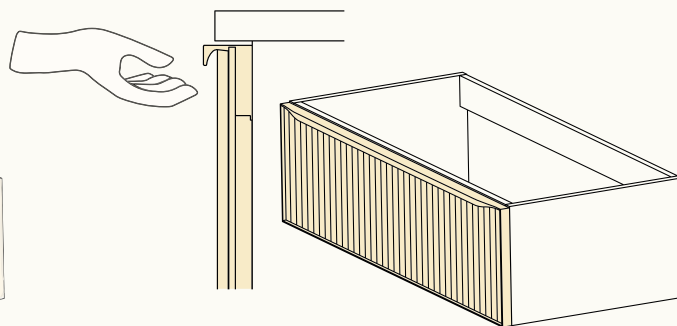

Perfil negro  
Se puede escoger el color del cristal diferente al del mueble

Silver

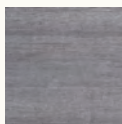

Carbon



Brown

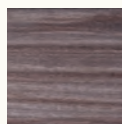

Artic

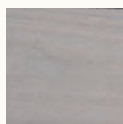

Cocoa

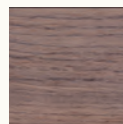

Camel

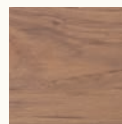

Savana

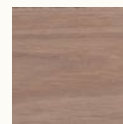

Nogal

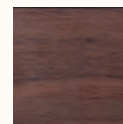

## 2 Escoge la estructura del mueble

En todos los diseños Play se pueden escoger dos opciones de estructura.

### Frontal

El tirador solapa la estructura del mueble.

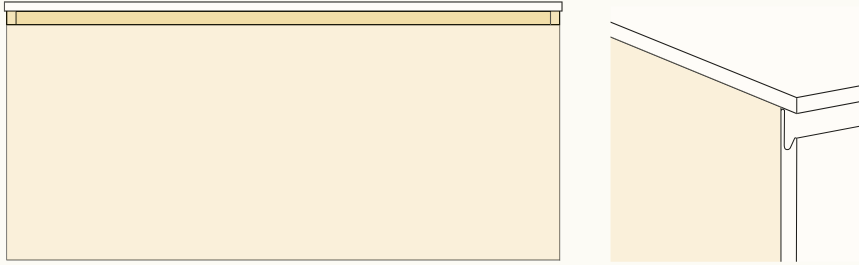

### Lateral

Los laterales del mueble quedan vistos como terminal decorativo.

- Especialmente recomendado en casos en los que el mueble vaya registrado a una pared.
- En caso de modular más de una base sólo quedarán a la vista los extremos de la composición.

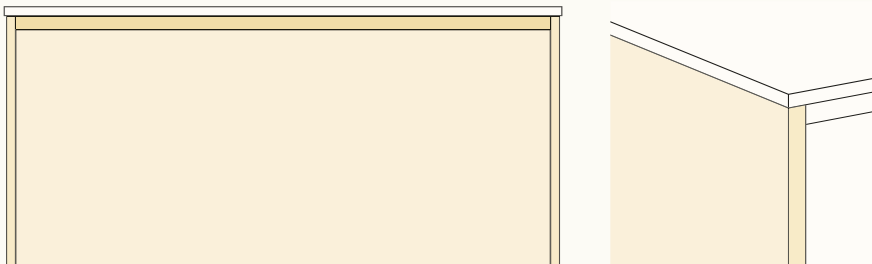

De forma standard el color de la estructura es igual al color de tirador.

Si se desea se puede escoger el color de la estructura diferente al color del tirador. Especificar.

Blanco Mate Blanco Brillo	Negro Mate Negro Brillo	Beige Mate Beige Brillo	Tierra Mate Tierra Brillo	Caqui Mate Caqui Brillo	Cuarzo Mate Cuarzo Brillo	Moka Mate Moka Brillo	Perla Mate Perla Brillo	Piedra Mate Piedra Brillo
Acero Mate Acero Brillo	Antracita Mate Antracita Brillo	Burdeos Mate Burdeos Brillo	Océano Mate Océano Brillo	Menta Mate Menta Brillo	Oliva Mate Oliva Brillo	Terracota Mate Terracota Brillo	Albero Mate Albero Brillo	Rosa Mate Rosa Brillo
Silver	Carbon	Brown	Artic	Cocoa	Camel	Savana	Nogal	

### BASES DE LAVABO SUSPENDIDAS

#### 1 CAJÓN

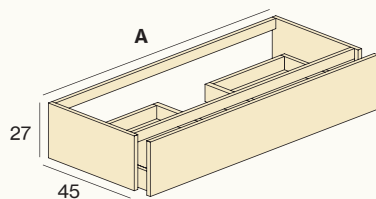

A (cm)	LAVABO	REF	MADERA NATURE		LACA	
			BLACK-INCOLOR-NEO-RAIL	PUSH	BLACK-CURVE-LINEAL-INCOLOR-INGLETE-NEO-RAIL	LINE-GLASS-FRAME-PUSH
60		P101.060.C	-	-	-	-
70		P101.070.C	-	-	-	-
80		P101.080.C	-	-	-	-
90		P101.090.C	-	-	-	-
100		P101.100.I	-	-	-	-
100		P101.100.C	-	-	-	-
100		P101.100.D	-	-	-	-
120		P101.120.I	-	-	-	-
120		P101.120.C	-	-	-	-
120		P101.120.D	-	-	-	-
120		P101.120.X	-	-	-	-
140		P101.140.I	-	-	-	-
140		P101.140.C	-	-	-	-
140		P101.140.D	-	-	-	-
140		P101.140.X	-	-	-	-

#### 2 CAJONES ASIMÉTRICOS

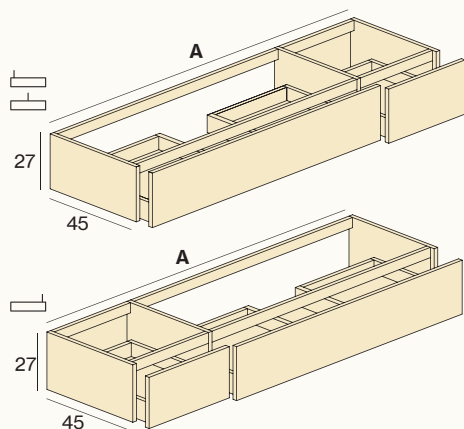

120		P102.120.I	-	-	-	-
120		P102.120.C	-	-	-	-
120		P102.120.D	-	-	-	-
140		P102.140.I	-	-	-	-
140		P102.140.C	-	-	-	-
140		P102.140.D	-	-	-	-
160		P102.160.I	-	-	-	-
160		P102.160.C	-	-	-	-
160		P102.160.D	-	-	-	-
180		P102.180.I	-	-	-	-
180		P102.180.C	-	-	-	-
180		P102.180.D	-	-	-	-
200		P102.200.I	-	-	-	-
200		P102.200.C	-	-	-	-
200		P102.200.D	-	-	-	-

#### 2 CAJONES SIMÉTRICOS

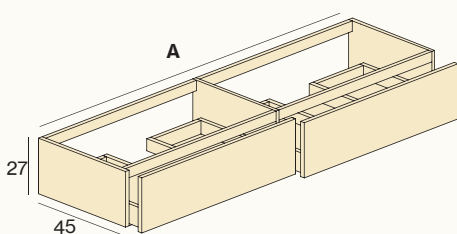

120		P103.120.I	-	-	-	-
120		P103.120.D	-	-	-	-
120		P103.120.X	-	-	-	-
140		P103.140.I	-	-	-	-
140		P103.140.D	-	-	-	-
140		P103.140.X	-	-	-	-
160		P103.160.I	-	-	-	-
160		P103.160.D	-	-	-	-
160		P103.160.X	-	-	-	-
180		P103.180.I	-	-	-	-
180		P103.180.D	-	-	-	-
180		P103.180.X	-	-	-	-
200		P103.200.I	-	-	-	-
200		P103.200.D	-	-	-	-
200		P103.200.X	-	-	-	-



- Las composiciones asimétricas tienen la siguiente modulación: 120 (80+40), 140 (100+40), 160 (100+60), 180 (120+60), 200 (120+80). Otras configuraciones disponibles.
- Muebles especiales: Para medidas intermedias en anchura y/o altura tomar el precio de la medida inmediatamente superior. Otras medidas especiales consultar.

#### & complementa

Organizadores, patas,  
toalleros, retroiluminación  
Pág.....248

- C Lavabo centrado
- D Lavabo derecho
- I Lavabo izquierdo
- X Lavabo doble

### BASES DE LAVABO SUSPENDIDAS

#### 2 CAJONES

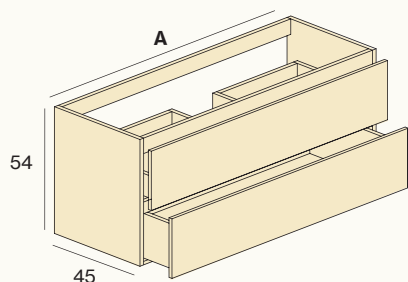

A (cm)	LAVABO	REF	MADERA NATURE		LACA	
			BLACK-INCOLOR-NEO-RAIL	PUSH	BLACK-CURVE-LINEAL-INCOLOR-INGLETE-NEO-RAIL	LINE-GLASS-FRAME-PUSH
60		P201.060.C	-	-	-	-
70		P201.070.C	-	-	-	-
80		P201.080.C	-	-	-	-
90		P201.090.C	-	-	-	-
100		P201.100.I	-	-	-	-
100		P201.100.C	-	-	-	-
100		P201.100.D	-	-	-	-
120		P201.120.I	-	-	-	-
120		P201.120.C	-	-	-	-
120		P201.120.D	-	-	-	-
120		P201.120.X	-	-	-	-
140		P201.140.I	-	-	-	-
140		P201.140.C	-	-	-	-
140		P201.140.D	-	-	-	-
140		P201.140.X	-	-	-	-

#### 1 BAÚL

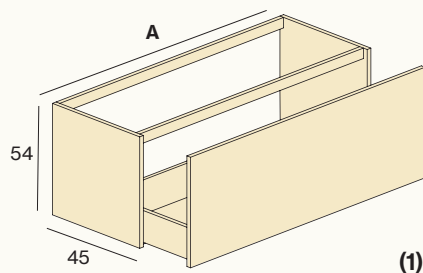

60		P202.060.C	-	-	-	-
70		P202.070.C	-	-	-	-
80		P202.080.C	-	-	-	-
90		P202.090.C	-	-	-	-
100		P202.100.I	-	-	-	-
100		P202.100.C	-	-	-	-
100		P202.100.D	-	-	-	-
120		P202.120.I	-	-	-	-
120		P202.120.C	-	-	-	-
120		P202.120.D	-	-	-	-
120		P202.120.X	-	-	-	-
140		P202.140.I	-	<b>ND</b>	-	-
140		P202.140.C	-	<b>ND</b>	-	-
140		P202.140.D	-	<b>ND</b>	-	-
140		P202.140.X	-	<b>ND</b>	-	-

· Ancho 140 cm no disponible para frontal con tirador push

#### 1 CAJÓN + DECORATIVO

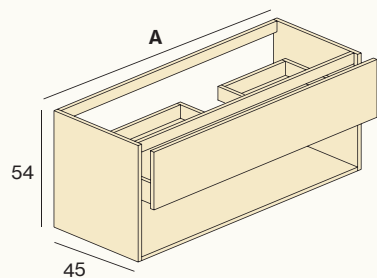

60		P203.060.C	-	-	-	-
70		P203.070.C	-	-	-	-
80		P203.080.C	-	-	-	-
90		P203.090.C	-	-	-	-
100		P203.100.I	-	-	-	-
100		P203.100.C	-	-	-	-
100		P203.100.D	-	-	-	-
120		P203.120.I	-	-	-	-
120		P203.120.C	-	-	-	-
120		P203.120.D	-	-	-	-
120		P203.120.X	-	-	-	-
140		P203.140.I	-	-	-	-
140		P203.140.C	-	-	-	-
140		P203.140.D	-	-	-	-
140		P203.140.X	-	-	-	-

#### (1) CAJÓN INTERIOR

El cajón interior se puede poner en las composiciones con baúl.

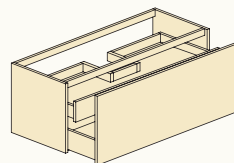

A (cm)	REF	PVP
40	P220.040	-
60	P220.060	-
70	P220.070	-
80	P220.080	-
90	P220.090	-
100	P220.100	-
120	P220.120	-
120X	P220.120X	-
140	P220.140	-
140X	P220.140X	-

### BASES DE LAVABO SUSPENDIDAS

#### 2 CAJONES + PUERTA

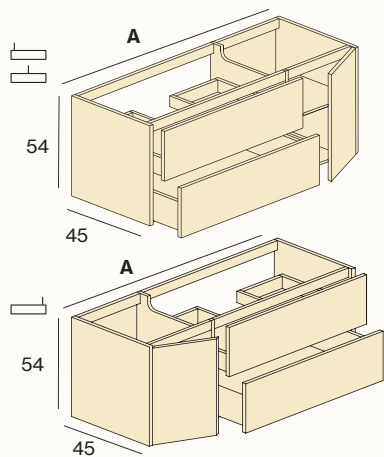

A (cm)	LAVABO	REF	MADERA NATURE		LACA	
			BLACK-INCOLOR-NEO-RAIL	PUSH	BLACK-CURVE-LINEAL-INCOLOR-INGLETE-NEO-RAIL	LINE-GLASS-FRAME-PUSH
120		P204.120.I	-	-	-	-
120		P204.120.C	-	-	-	-
120		P204.120.D	-	-	-	-
140		P204.140.I	-	-	-	-
140		P204.140.C	-	-	-	-
140		P204.140.D	-	-	-	-
160		P204.160.I	-	-	-	-
160		P204.160.C	-	-	-	-
160		P204.160.D	-	-	-	-
180		P204.180.I	-	-	-	-
180		P204.180.C	-	-	-	-
180		P204.180.D	-	-	-	-

#### BAÚL + 2 CAJONES ASIMÉTRICOS

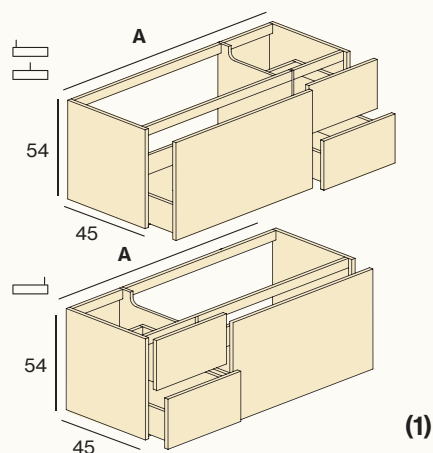

120		P205.120.I	-	-	-	-
120		P205.120.C	-	-	-	-
120		P205.120.D	-	-	-	-
140		P205.140.I	-	-	-	-
140		P205.140.C	-	-	-	-
140		P205.140.D	-	-	-	-
160		P205.160.I	-	-	-	-
160		P205.160.C	-	-	-	-
160		P205.160.D	-	-	-	-
180		P205.180.I	-	-	-	-
180		P205.180.C	-	-	-	-
180		P205.180.D	-	-	-	-
200		P205.200.I	-	-	-	-
200		P205.200.C	-	-	-	-
200		P205.200.D	-	-	-	-

#### BAÚL + 2 CAJONES SIMÉTRICOS

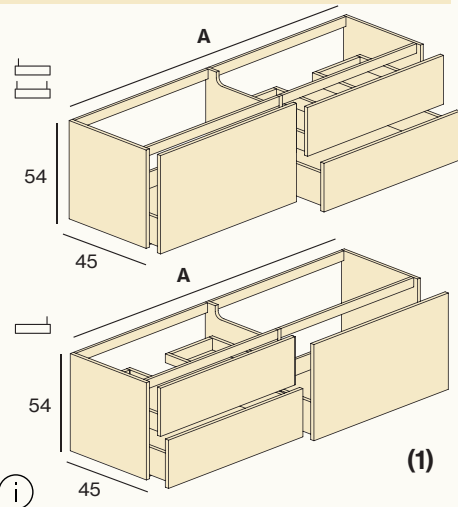

120		P206.120.I	-	-	-	-
120		P206.120.D	-	-	-	-
120		P206.120.X	-	-	-	-
140		P206.140.I	-	-	-	-
140		P206.140.D	-	-	-	-
140		P206.140.X	-	-	-	-
160		P206.160.I	-	-	-	-
160		P206.160.D	-	-	-	-
160		P206.160.X	-	-	-	-
180		P206.180.I	-	-	-	-
180		P206.180.D	-	-	-	-
180		P206.180.X	-	-	-	-
200		P206.200.I	-	-	-	-
200		P206.200.D	-	-	-	-
200		P206.200.X	-	-	-	-



- Las composiciones asimétricas tienen la siguiente modulación: 120 (80+40), 140 (100+40), 160 (100+60), 180 (120+60), 200 (120+80). Otras configuraciones disponibles.
- Muebles especiales: Para medidas intermedias en anchura y/o altura tomar el precio de la medida inmediatamente superior. Otras medidas especiales consultar.

#### & complementa

Organizadores, patas,  
toalleros, retroiluminación  
Pág.....248

- C Lavabo centrado
- D Lavabo derecho
- I Lavabo izquierdo
- X Lavabo doble



BASES DE LAVABO SUSPENDIDAS

4 CAJONES ASIMÉTRICOS

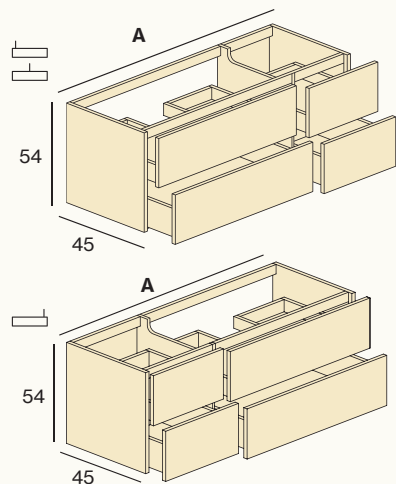

A (cm)	LAVABO	REF	MADERA NATURE		LACA	
			BLACK-INCOLOR-NEO-RAIL	PUSH	BLACK-CURVE-LINEAL-INCOLOR-INGLETE-NEO-RAIL	LINE-GLASS-FRAME-PUSH
120		P208.120.I	-	-	-	-
120		P208.120.C	-	-	-	-
120		P208.120.D	-	-	-	-
140		P208.140.I	-	-	-	-
140		P208.140.C	-	-	-	-
140		P208.140.D	-	-	-	-
160		P208.160.I	-	-	-	-
160		P208.160.C	-	-	-	-
160		P208.160.D	-	-	-	-
180		P208.180.I	-	-	-	-
180		P208.180.C	-	-	-	-
180		P208.180.D	-	-	-	-
200		P208.200.I	-	-	-	-
200		P208.200.C	-	-	-	-
200		P208.200.D	-	-	-	-

4 CAJONES SIMÉTRICOS

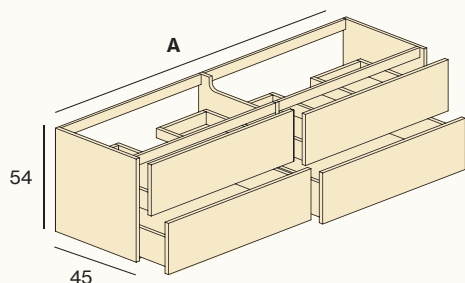

120		P209.120.I	-	-	-	-
120		P209.120.D	-	-	-	-
120		P209.120.X	-	-	-	-
140		P209.140.I	-	-	-	-
140		P209.140.D	-	-	-	-
140		P209.140.X	-	-	-	-
160		P209.160.I	-	-	-	-
160		P209.160.D	-	-	-	-
160		P209.160.X	-	-	-	-
180		P209.180.I	-	-	-	-
180		P209.180.D	-	-	-	-
180		P209.180.X	-	-	-	-
200		P209.200.I	-	-	-	-
200		P209.200.D	-	-	-	-
200		P209.200.X	-	-	-	-

2 CAJONES + DECORATIVO

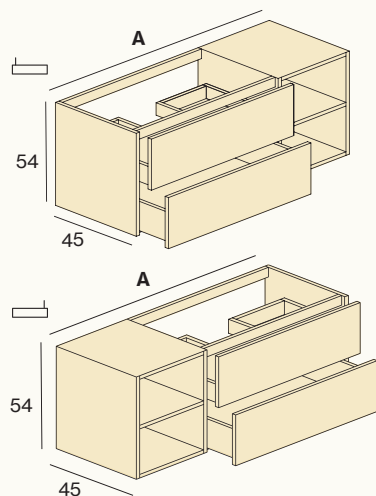

120		P207.120.I	-	-	-	-
120		P207.120.D	-	-	-	-
140		P207.140.I	-	-	-	-
140		P207.140.D	-	-	-	-
160		P207.160.I	-	-	-	-
160		P207.160.D	-	-	-	-
180		P207.180.I	-	-	-	-
180		P207.180.D	-	-	-	-

(1) CAJÓN INTERIOR

El cajón interior se puede poner en las composiciones con baúl.

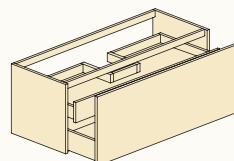

A (cm)	REF	PVP
40	P220.040	-
60	P220.060	-
70	P220.070	-
80	P220.080	-
90	P220.090	-
100	P220.100	-
120	P220.120	-
120X	P220.120X	-
140	P220.140	-
140X	P220.140X	-

### BASES DE LAVABO SUSPENDIDAS

#### 2 BAÚLES ASIMÉTRICOS

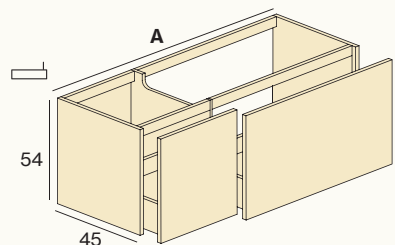
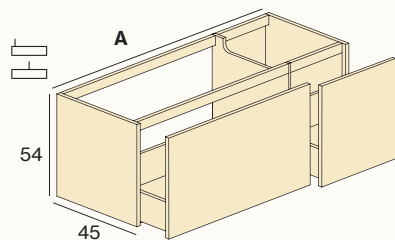

(1)

#### 2 BAÚLES SIMÉTRICOS

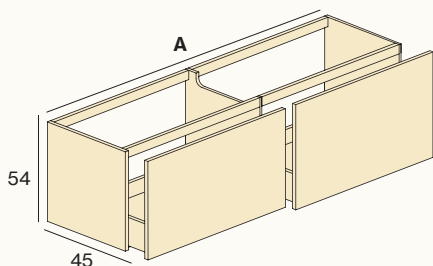

(1)

#### 1 CAJÓN + BAÚL

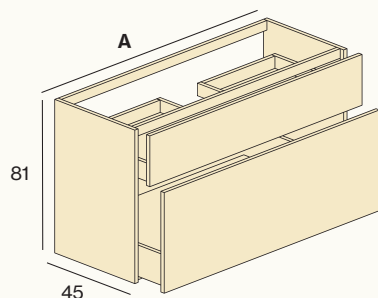

(1)

A (cm)	LAVABO	REF	MADERA NATURE		LACA	
			BLACK-INCOLOR-NEO-RAIL	PUSH	BLACK-CURVE-LINEAL-INCOLOR-INGLETE-NEO-RAIL	LINE-GLASS-FRAME-PUSH
120		P210.120.I	-	-	-	-
120		P210.120.C	-	-	-	-
120		P210.120.D	-	-	-	-
140		P210.140.I	-	-	-	-
140		P210.140.C	-	-	-	-
140		P210.140.D	-	-	-	-
160		P210.160.I	-	-	-	-
160		P210.160.C	-	-	-	-
160		P210.160.D	-	-	-	-
180		P210.180.I	-	-	-	-
180		P210.180.C	-	-	-	-
180		P210.180.D	-	-	-	-
200		P210.200.I	-	-	-	-
200		P210.200.C	-	-	-	-
200		P210.200.D	-	-	-	-

120		P211.120.I	-	-	-	-
120		P211.120.D	-	-	-	-
120		P211.120.X	-	-	-	-
140		P211.140.I	-	-	-	-
140		P211.140.D	-	-	-	-
140		P211.140.X	-	-	-	-
160		P211.160.I	-	-	-	-
160		P211.160.D	-	-	-	-
160		P211.160.X	-	-	-	-
180		P211.180.I	-	-	-	-
180		P211.180.D	-	-	-	-
180		P211.180.X	-	-	-	-
200		P211.200.I	-	-	-	-
200		P211.200.D	-	-	-	-
200		P211.200.X	-	-	-	-

60		P312.060.C	-	-	-	-
70		P312.070.C	-	-	-	-
80		P312.080.C	-	-	-	-
90		P312.090.C	-	-	-	-
100		P312.100.I	-	-	-	-
100		P312.100.C	-	-	-	-
100		P312.100.D	-	-	-	-
120		P312.120.I	-	-	-	-
120		P312.120.C	-	-	-	-
120		P312.120.D	-	-	-	-



- Las composiciones asimétricas tienen la siguiente modulación: 120 (80+40), 140 (100+40), 160 (100+60), 180 (120+60), 200 (120+80). Otras configuraciones disponibles.
- Muebles especiales: Para medidas intermedias en anchura y/o altura tomar el precio de la medida inmediatamente superior. Otras medidas especiales consultar.

#### & complementa

Organizadores, patas, toalleros, retroiluminación  
Pág.....248

- C Lavabo centrado
- D Lavabo derecho
- I Lavabo izquierdo
- X Lavabo doble

**BASES DE LAVABO SUSPENDIDAS**

**3 CAJONES**

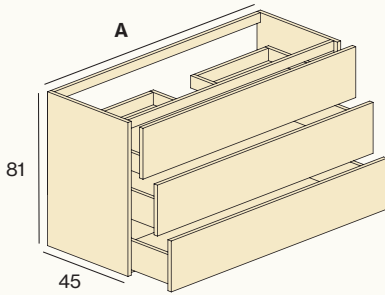

A (cm)	LAVABO	REF	MADERA NATURE		LACA	
			BLACK-INCOLOR-NEO-RAIL	PUSH	BLACK-CURVE-LINEAL-INCOLOR-INGLETE-NEO-RAIL	LINE-GLASS-FRAME-PUSH
60		P313.060.C	-	-	-	-
70		P313.070.C	-	-	-	-
80		P313.080.C	-	-	-	-
90		P313.090.C	-	-	-	-
100		P313.100.I	-	-	-	-
100		P313.100.C	-	-	-	-
100		P313.100.D	-	-	-	-
120		P313.120.I	-	-	-	-
120		P313.120.C	-	-	-	-
120		P313.120.D	-	-	-	-

**BASES DE LAVABO METÁLICAS SUSPENDIDAS**

**ESTRUCTURA METÁLICA SUSPENDIDA**

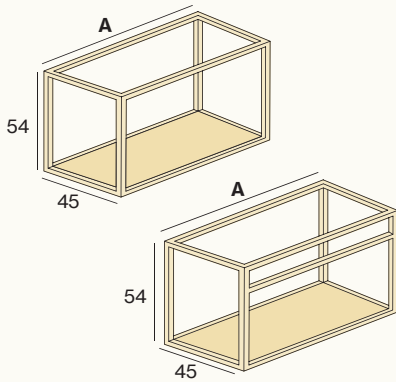

A (cm)	REF	NEGRO			COLOR		
		MADERA NATURE	LACA	CRISTAL FUMÉ	MADERA NATURE	LACA	CRISTAL FUMÉ
60	P214.060.C	-	-	-	-	-	-
70	P214.070.C	-	-	-	-	-	-
80	P214.080.C	-	-	-	-	-	-
90	P214.090.C	-	-	-	-	-	-
100	P214.100.C	-	-	-	-	-	-
120	P214.120.C	-	-	-	-	-	-
140	P214.140.C	-	-	-	-	-	-
60	P216.060.C	-	-	-	-	-	-
70	P216.070.C	-	-	-	-	-	-
80	P216.080.C	-	-	-	-	-	-
90	P216.090.C	-	-	-	-	-	-
100	P216.100.C	-	-	-	-	-	-
120	P216.120.C	-	-	-	-	-	-
140	P216.140.C	-	-	-	-	-	-

**ESTRUCTURA METÁLICA A SUELO**

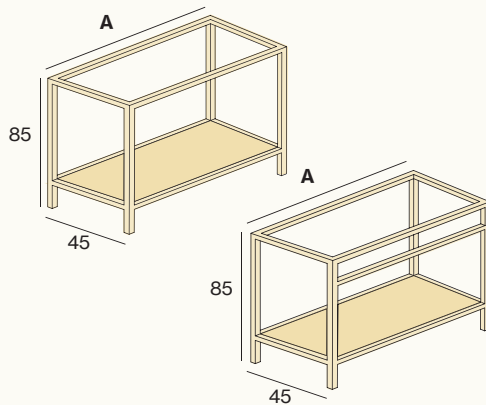

60	P215.060.C	-	-	-	-	-	-
70	P215.070.C	-	-	-	-	-	-
80	P215.080.C	-	-	-	-	-	-
90	P215.090.C	-	-	-	-	-	-
100	P215.100.C	-	-	-	-	-	-
120	P215.120.C	-	-	-	-	-	-
140	P215.140.C	-	-	-	-	-	-
60	P217.060.C	-	-	-	-	-	-
70	P217.070.C	-	-	-	-	-	-
80	P217.080.C	-	-	-	-	-	-
90	P217.090.C	-	-	-	-	-	-
100	P217.100.C	-	-	-	-	-	-
120	P217.120.C	-	-	-	-	-	-
140	P217.140.C	-	-	-	-	-	-

**(1) CAJÓN INTERIOR**

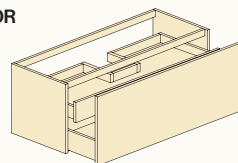

El cajón interior se puede poner en las composiciones con baúl.

A (cm)	REF	PVP
40	P220.040	-
60	P220.060	-
70	P220.070	-
80	P220.080	-
90	P220.090	-
100	P220.100	-
120	P220.120	-
120X	P220.120X	-
140	P220.140	-
140X	P220.140X	-

### MÓDULOS SUSPENDIDOS

#### 1 CAJÓN / BANCADA

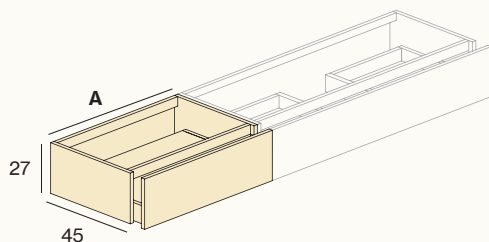

A (cm)	REF	MADERA NATURE		LACA	
		BLACK-INCOLOR-NEO-RAIL	PUSH	BLACK-CURVE-LINEAL-INCOLOR-INGLETE-NEO-RAIL	LINE-GLASS-FRAME-PUSH
30	P101.030.M	-	-	-	-
40	P101.040.M	-	-	-	-
60	P101.060.M	-	-	-	-
70	P101.070.M	-	-	-	-
80	P101.080.M	-	-	-	-
90	P101.090.M	-	-	-	-
100	P101.100.M	-	-	-	-
120	P101.120.M	-	-	-	-
140	P101.140.M	-	-	-	-

#### 2 CAJONES / BANCADA

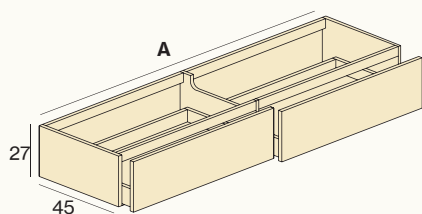

120	P103.120.M	-	-	-	-
140	P103.140.M	-	-	-	-
160	P103.160.M	-	-	-	-
180	P103.180.M	-	-	-	-
200	P103.200.M	-	-	-	-

#### DECORATIVO

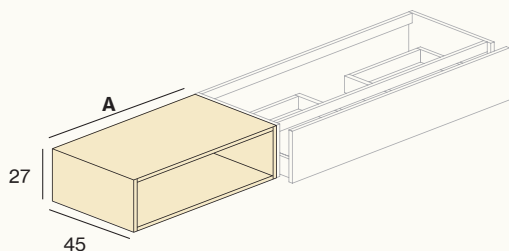

30	P104.030.M	-	-	-	-
40	P104.040.M	-	-	-	-
60	P104.060.M	-	-	-	-
70	P104.070.M	-	-	-	-
80	P104.080.M	-	-	-	-



· Puede crear su mueble personalizado añadiendo los módulos a derecha y/o izquierda de la base de lavabo seleccionada. Especifique la posición de los mismos.

MÓDULOS SUSPENDIDOS

1 PUERTA

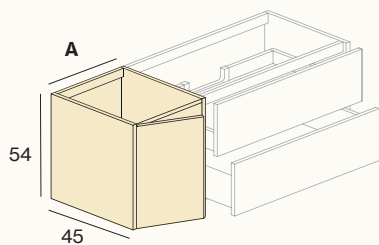

A (cm)	PUERTA	REF	MADERA NATURE		LACA	
			BLACK-INCOLOR-NEO-RAIL	PUSH	BLACK-CURVE-LINEAL-INCOLOR-INGLETE-NEO-RAIL	LINE-GLASS-FRAME-PUSH
30		P204.030.MI	-	-	-	-
30		P204.030.MD	-	-	-	-
40		P204.040.MI	-	-	-	-
40		P204.040.MD	-	-	-	-

2 CAJONES

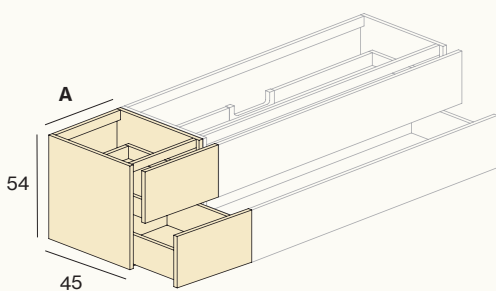

A (cm)	REF	MADERA NATURE		LACA	
		BLACK-INCOLOR-NEO-RAIL	PUSH	BLACK-CURVE-LINEAL-INCOLOR-INGLETE-NEO-RAIL	LINE-GLASS-FRAME-PUSH
30	P201.030.M	-	-	-	-
40	P201.040.M	-	-	-	-
60	P201.060.M	-	-	-	-
70	P201.070.M	-	-	-	-
80	P201.080.M	-	-	-	-
90	P201.090.M	-	-	-	-
100	P201.100.M	-	-	-	-
120	P201.120.M	-	-	-	-
140	P201.140.M	-	-	-	-

1 BAÚL

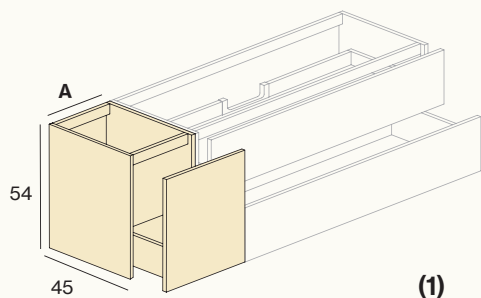

30	P202.030.M	-	-	-	-
40	P202.040.M	-	-	-	-
60	P202.060.M	-	-	-	-
70	P202.070.M	-	-	-	-
80	P202.080.M	-	-	-	-
90	P202.090.M	-	-	-	-
100	P202.100.M	-	-	-	-
120	P202.120.M	-	-	-	-
140	P202.140.M	-	ND	-	-

· Ancho 140 cm no disponible para frontal con tirador push.

**(1) CAJÓN INTERIOR**  
El cajón interior se puede poner en las composiciones con baúl.

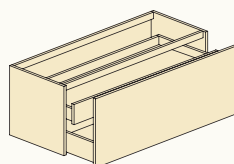

A (cm)	REF	PVP
40	A221.040	-
60	A221.060	-
70	A221.070	-
80	A221.080	-
90	A221.090	-
100	A221.100	-
120	A221.120	-
140	A221.140	-

MÓDULOS SUSPENDIDOS

1 CAJÓN + DECORATIVO

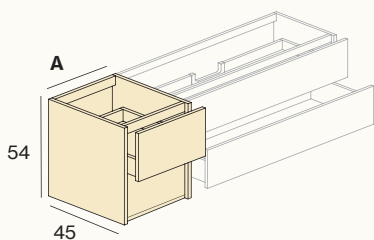

A (cm)	REF	MADERA NATURE		LACA	
		BLACK-INCOLOR-NEO-RAIL	PUSH	BLACK-CURVE-LINEAL-INCOLOR-INGLETE-NEO-RAIL	LINE-GLASS-FRAME-PUSH
30	P203.030.M	-	-	-	-
40	P203.040.M	-	-	-	-
60	P203.060.M	-	-	-	-
70	P203.070.M	-	-	-	-
80	P203.080.M	-	-	-	-
90	P203.090.M	-	-	-	-
100	P203.100.M	-	-	-	-
120	P203.120.M	-	-	-	-
140	P203.140.M	-	-	-	-

DECORATIVO ESTANTES

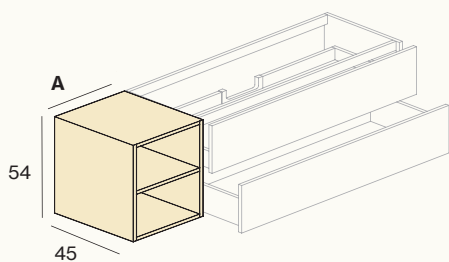

30	P207.030.M	-	-	-	-
40	P207.040.M	-	-	-	-
60	P207.060.M	-	-	-	-
70	P207.070.M	-	-	-	-
80	P207.080.M	-	-	-	-

1 CAJÓN + PUERTA

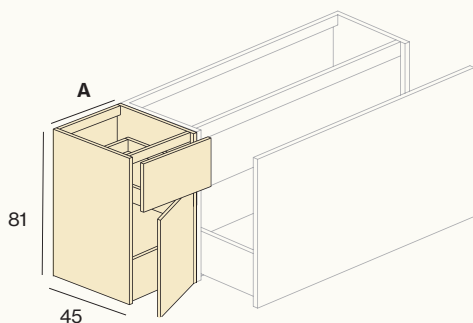

A (cm)	PUERTA	REF	MADERA NATURE		LACA	
			BLACK-INCOLOR-NEO-RAIL	PUSH	BLACK-CURVE-LINEAL-INCOLOR-INGLETE-NEO-RAIL	LINE-GLASS-FRAME-PUSH
30		P314.030.MI	-	-	-	-
30		P314.030.MD	-	-	-	-
40		P314.040.MI	-	-	-	-
40		P314.040.MD	-	-	-	-



· Puede crear su mueble personalizado añadiendo los módulos a derecha y/o izquierda de la base de lavabo seleccionada. Especifique la posición de los mismos.

MÓDULOS SUSPENDIDOS

3 CAJONES

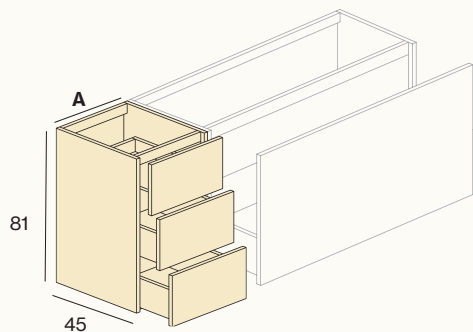

A (cm)	REF	MADERA NATURE		LACA	
		BLACK-INCOLOR-NEO-RAIL	PUSH	BLACK-CURVE-LINEAL-INCOLOR-INGLETE-NEO-RAIL	LINE-GLASS-FRAME-PUSH
30	P313.030.M	-	-	-	-
40	P313.040.M	-	-	-	-
60	P313.060.M	-	-	-	-
70	P313.070.M	-	-	-	-
80	P313.080.M	-	-	-	-
90	P313.090.M	-	-	-	-
100	P313.100.M	-	-	-	-
120	P313.120.M	-	-	-	-

MÓDULOS ESTRUCTURA METÁLICA SUSPENDIDOS

DECORATIVO METÁLICO

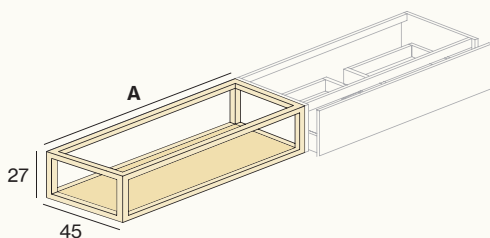

A (cm)	REF	NEGRO			COLOR		
		MADERA NATURE	LACA	CRISTAL FUMÉ	MADERA NATURE	LACA	CRISTAL FUMÉ
30	P105.030.M	-	-	-	-	-	-
40	P105.040.M	-	-	-	-	-	-
60	P105.060.M	-	-	-	-	-	-
70	P105.070.M	-	-	-	-	-	-
80	P105.080.M	-	-	-	-	-	-
90	P105.090.M	-	-	-	-	-	-
100	P105.100.M	-	-	-	-	-	-
120	P105.120.M	-	-	-	-	-	-
140	P105.140.M	-	-	-	-	-	-

DECORATIVO METÁLICO H54

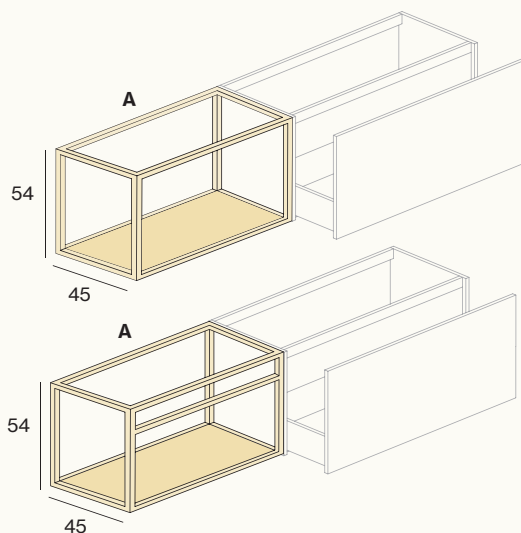

30	P214.030.M	-	-	-	-	-	-
40	P214.040.M	-	-	-	-	-	-
60	P214.060.M	-	-	-	-	-	-
70	P214.070.M	-	-	-	-	-	-
80	P214.080.M	-	-	-	-	-	-
90	P214.090.M	-	-	-	-	-	-
100	P214.100.M	-	-	-	-	-	-
120	P214.120.M	-	-	-	-	-	-
140	P214.140.M	-	-	-	-	-	-

  

30	P216.030.M	-	-	-	-	-	-
40	P216.040.M	-	-	-	-	-	-
60	P216.060.M	-	-	-	-	-	-
70	P216.070.M	-	-	-	-	-	-
80	P216.080.M	-	-	-	-	-	-
90	P216.090.M	-	-	-	-	-	-
100	P216.100.M	-	-	-	-	-	-
120	P216.120.M	-	-	-	-	-	-
140	P216.140.M	-	-	-	-	-	-

### INTERIOR MUEBLE

#### DECOSPACE

Sistema que incluye un sifón ahorra-espacio y una válvula clic-clac cromo brillo. Esta solución permite que el cajón superior vaya sin registro de sifón.

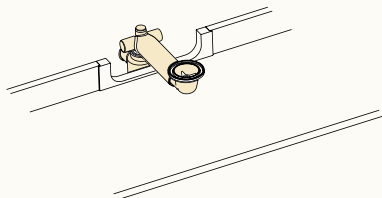

REF	PVP
CM13	-
CM13X2	-

#### ORGADRAW

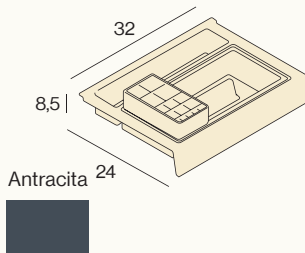

REF	PVP
CM1	-

#### ORGASTRIP

Sistema de separadores guiados por railes.

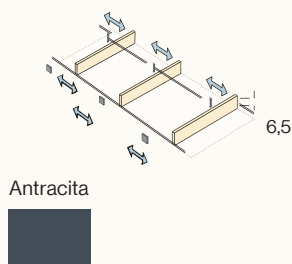

A	REF	SEPARADORES	PVP
30	CM2.030	1	-
40	CM2.040	1	-
60	CM2.060	2	-
70	CM2.070	2	-
80	CM2.080	3	-
90	CM2.090	3	-
100	CM2.100	4	-
120	CM2.120	4	-
140	CM2.140	4	-

#### Separador adicional

CM2.010	1	-
---------	---	---

#### PROTECCIÓN CAJÓN

Lámina protectora antideslizante para cajón.



A	PERLA		TEJA	
	REF	PVP	REF	PVP
30	CM3.030	-	CM4.030	-
40	CM3.040	-	CM4.040	-
60	CM3.060	-	CM4.060	-
70	CM3.070	-	CM4.070	-
80	CM3.080	-	CM4.080	-
90	CM3.090	-	CM4.090	-
100	CM3.100	-	CM4.100	-
120	CM3.120	-	CM4.120	-
140	CM3.140	-	CM4.140	-



PATAS DE MUEBLE

ESTRUCTURA METAL CON ESTANTE PARA MUEBLE H27

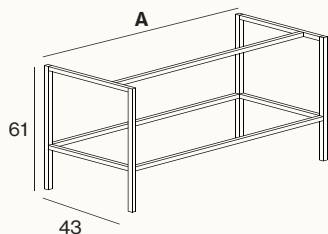

A (cm)	REF	NEGRO			COLOR		
		MADERA NATURE	LACA	CRISTAL FUMÉ	MADERA NATURE	LACA	CRISTAL FUMÉ
60	CM14.060	-	-	-	-	-	-
70	CM14.070	-	-	-	-	-	-
80	CM14.080	-	-	-	-	-	-
90	CM14.090	-	-	-	-	-	-
100	CM14.100	-	-	-	-	-	-
120	CM14.120	-	-	-	-	-	-
140	CM14.140	-	-	-	-	-	-

Colores



ESTRUCTURA METAL PARA MUEBLE H54

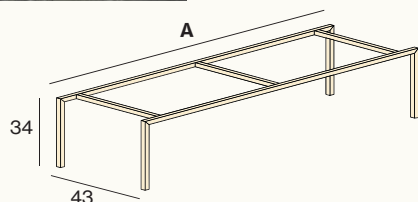

A	REF	NEGRO	COLOR
60	CM5.060	-	-
70	CM5.070	-	-
80	CM5.080	-	-
90	CM5.090	-	-
100	CM5.100	-	-
120	CM5.120	-	-
140	CM5.140	-	-
160	CM5.160	-	-
180	CM5.180	-	-
200	CM5.200	-	-

La medida del fondo de la estructura es aproximadamente 2 centímetros inferior respecto el fondo del mueble para no interferir con los frontales.

Colores



PATASH3

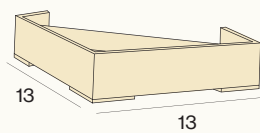

Cromo Brillo



REF

PVP

CM6

-

3,6 Juego de 4 unidades

PATASH7

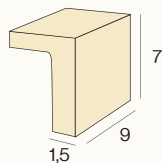

Cromo Brillo



REF

PVP

CM7

-

7 Juego de 4 unidades

### EXTERIOR MUEBLE

#### TOALLERO LATERAL

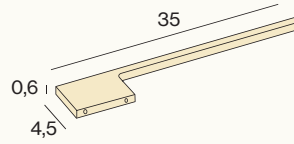

COLOR	REF	PVP
-------	-----	-----

Cromo brillo	CM8.CB	-
Negro mate	CM8.BK	-
Color (carta laca)	CM8.CO	-

#### Colores



#### TOALLERO DE PIE

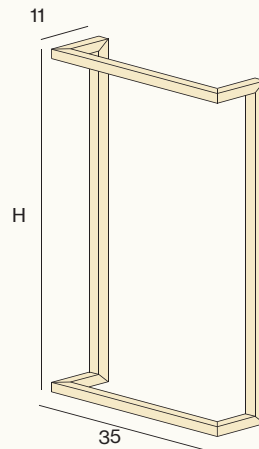

H	COLOR	REF	PVP
---	-------	-----	-----

75	Negro mate	CM9.75.BK	-
75	Color (carta laca)	CM9.75.CO	-
85	Negro mate	CM9.85.BK	-
85	Color (carta laca)	CM9.85.CO	-

H = 85 cm para mueble con lavabo integrado.

H = 75 cm para mueble con lavabo sobre encimera.

#### Colores



#### RETROILUMINACIÓN INFERIOR MUEBLE

Iluminación debajo del mueble, debajo de encimera mural, armario de colgar o interior de columna.

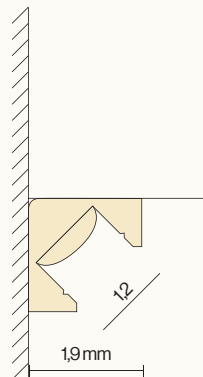

A	REF	PVP
---	-----	-----

60	CM10.060	-
70	CM10.070	-
80	CM10.080	-
90	CM10.090	-
100	CM10.100	-
120	CM10.120	-
140	CM10.140	-
160	CM10.160	-
180	CM10.180	-
200	CM10.200	-

La medida real de la iluminación LED es 4 centímetros inferior respecto el ancho del mueble para que no se vea desde el lateral.

LUZ	COLOR*°K	CONSUMO	POTENCIA	ESTANQUEIDAD	DRIVER	MATERIAL
LED	4000°K Neutra	4,8W	400 LUMENS metro lineal	IP67	INCLUIDO	ALUMINIO

Personaliza tu LED en 3000°K y 4200°K sin extra de precio. Standard de 4000°K.

### EXTERIOR MUEBLE

#### REGLETA AJUSTE PAREDES

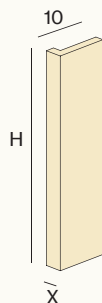

H	REF	MADERA NATURE	LACA
27	CM11.27	-	-
54	CM11.54	-	-
81	CM11.81	-	-

X a definir según necesidad.

#### DECORATIVOS LATERALES

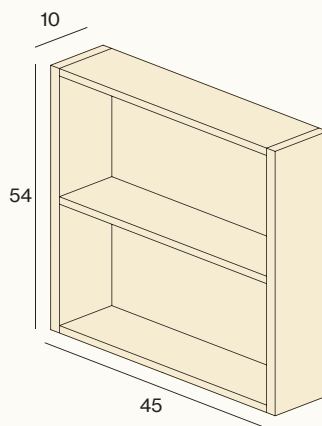

REF	MADERA NATURE	LACA
CM12	-	-



# Step

Características y equipamiento	254
Personaliza tu mueble Step	255
Bases de lavabo suspendidas	256
Pack mueble suspendido + encimera	257

**CAJONES 3D**

Cajones metálicos Hettich de color antracita y con 3 regulaciones de ajuste. Las guías son de extracción total y sistema de frenado progresivo.

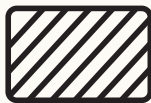
**ANTRACITA FULLCOLOR**

Concepto de diseño interior por el que todos los materiales del interior de los muebles están diseñados en color antracita. Los muebles con acabado lacado se lacan interiormente en color antracita.

**DECOBUILD SYSTEM**

Los muebles fabricados con tableros de 19 mm están encolados entre sí con clavillas consiguiendo una estética limpia sin herrajes visibles y ofreciendo mejor resistencia y durabilidad.

**SISTEMA COLGAR AUTODESCUELGUE**

Este sistema de fijación a pared tiene seguridad antidescuelgue con una capacidad de carga de 150 Kg.

## Escoge tu pack Step y personaliza

Nuestra selección siempre en stock

- ✓ Un acabado
- ✓ Dos colores
- ✓ Tres encimeras

### A Escoge el color

Lacados

Blanco Mate

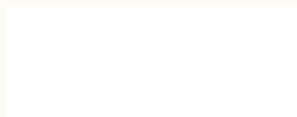

Madera Nature

Sand



### B Escoge la encimera

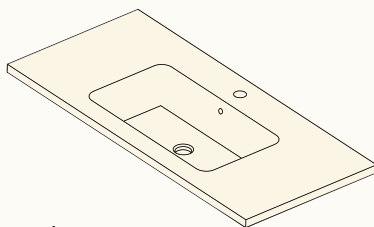

CERÁMICA

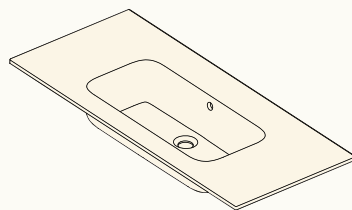

SOLID MINERAL - BRILLO

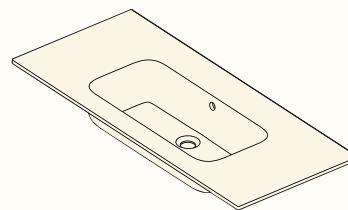

SOLID MINERAL - MATE

BASES DE LAVABO SUSPENDIDAS

2 CAJONES

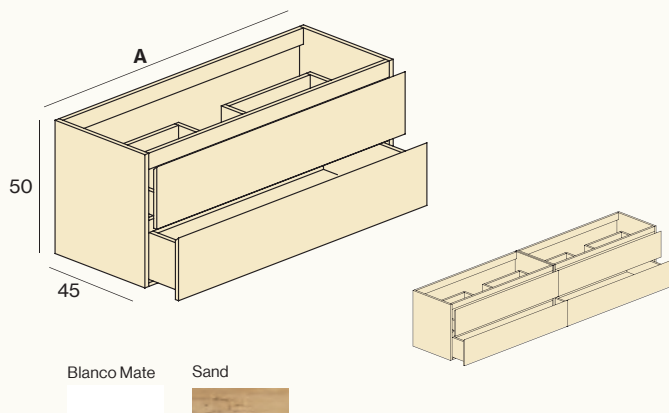

A (cm)	LAVABO	BLANCO	SAND	PVP
		REF	REF	
60		S201.060.CB	S201.060.CS	-
80		S201.080.CB	S201.080.CS	-
100		S201.100.CB	S201.100.CS	-
120		S201.120.CB	S201.120.CS	-
120X		S201.120.XB	S201.120.XS	-



· Producto en stock.



### PACK MUEBLE SUSPENDIDO + ENCIMERA

#### 2 CAJONES + ENCIMERA DE CERÁMICA

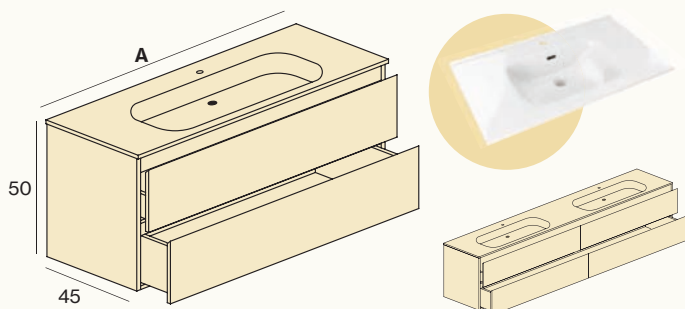

Blanco Mate

Sand



A (cm)	LAVABO	BLANCO	SAND	PVP
		REF	REF	
60		S901.060.CB	S901.060.CS	-
80		S901.080.CB	S901.080.CS	-
100		S901.100.CB	S901.100.CS	-
120		S901.120.CB	S901.120.CS	-
120X		S901.120.XB	S901.120.XS	-

#### 2 CAJONES + ENCIMERA SOLID - HARD (Brillo)

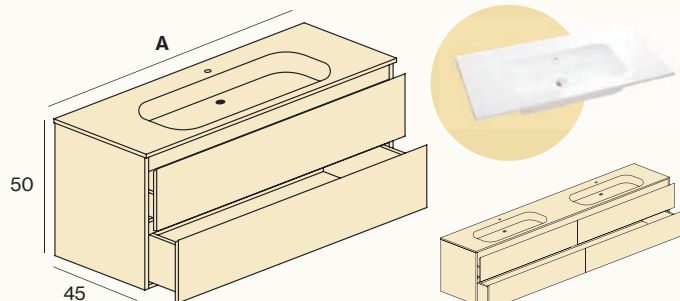

Blanco Mate

Sand

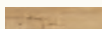

A (cm)	LAVABO	BLANCO	SAND	PVP
		REF	REF	
60		S902.060.CB	S902.060.CS	-
80		S902.080.CB	S902.080.CS	-
100		S902.100.CB	S902.100.CS	-
120		S902.120.CB	S902.120.CS	-
120X		S902.120.XB	S902.120.XS	-

#### 2 CAJONES + ENCIMERA SOLID - HARD (Mate)

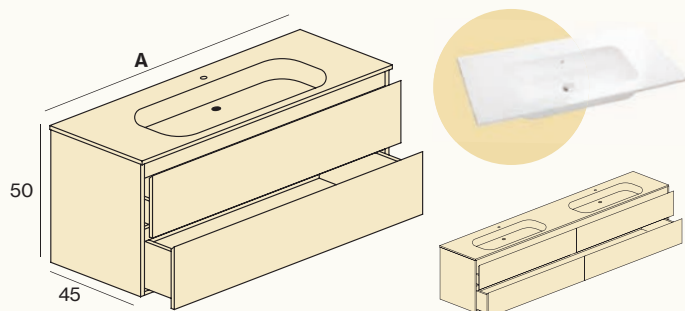

Blanco Mate

Sand

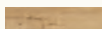
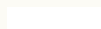

A (cm)	LAVABO	BLANCO	SAND	PVP
		REF	REF	
60		S903.060.CB	S903.060.CS	-
80		S903.080.CB	S903.080.CS	-
100		S903.100.CB	S903.100.CS	-
120		S903.120.CB	S903.120.CS	-
120X		S903.120.XB	S903.120.XS	-



· Producto en stock.



# 03 Encimeras

Integradas, planas, lavabos sobreencimera  
y totems. Soluciones y materiales para  
cada necesidad.

**MATERIALES**

Para conocer las características de nuestros materiales para encimeras y lavabos, consultar página 351.

**ENCIMERAS CON LAVABO INTEGRADO STANDARD**

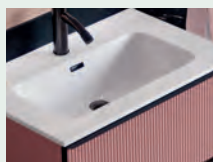

**Cerámicas**

pág. 262

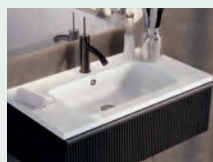

**Resina**

pág. 263



**Glass Blanco**

pág. 263

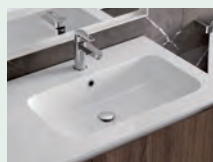

**Solid Mineral**

pág. 264

**ENCIMERAS CON LAVABO INTEGRADO A MEDIDA**

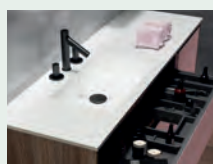

**Solid Mineral**

pág. 268



**Solid Surface  eco**

pág. 270

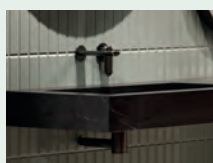

**Piedra Natural**

pág. 272



**Cristalcolor**

pág. 274

**LAVABO SOBRE ENCIMERA**



**Cerámica / Ceramcolor**

pág. 276

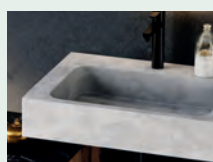

**Microcemento**

pág. 278



**Acero Inoxidable**

pág. 278

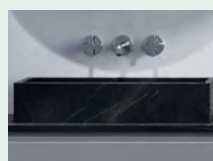

**Piedra Natural**

pág. 279



**Solid Surface  eco**

pág. 280

TOTEMS



**Solid Surface** 

pág. 283

ENCIMERAS PLANAS



**Madera Nature**

pág. 284

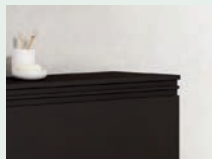

**Laca**

pág. 285



**Madera  
Tablero Marino**

pág. 286

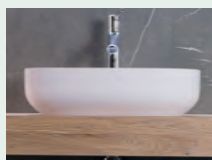

**Madera  
Roble Macizo**

pág. 287

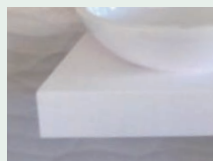

**Solid Mineral**

pág. 288

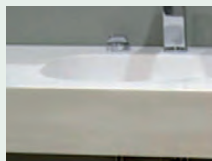

**Solid Surface** 

pág. 289



**Ceramcolor**

pág. 290



**Piedra Natural**

pág. 291

COMPLEMENTOS DE ENCIMERA



**Soportes murales**

pág. 292



**Válvulas**

pág. 292



**Sifones decorativos**

pág. 293



**Toalleros**

pág. 293



**Zócalos de encimera**

pág. 293

### CERÁMICAS

#### CERAMICS

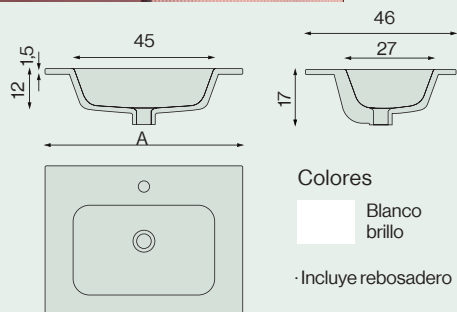

#### Colores

Blanco  
brillo

· Incluye rebosadero

#### POSICIÓN DE LAVABO

A (cm)

E (cm)

REF

PVP

#### CENTRADO

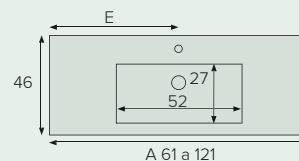

61	30	EC.061.C	-
71	35	EC.071.C	-
81	40	EC.081.C	-
91	45	EC.091.C	-
101	50	EC.101.C	-
121	60	EC.121.C	-

#### DERECHO

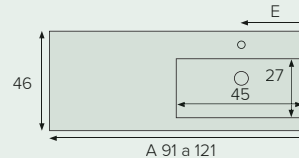

91	31	EC.091.D	-
101	34	EC.101.D	-
121	40	EC.121.D	-

#### IZQUIERDO

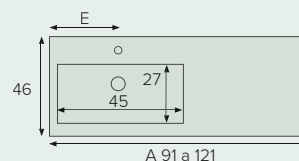

91	31	EC.091.I	-
101	34	EC.101.I	-
121	40	EC.121.I	-

#### DOBLE

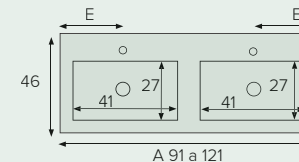

121	30	EC.121.X	-
141	35	EC.141.X	-

#### CERAMICS Fondo 39

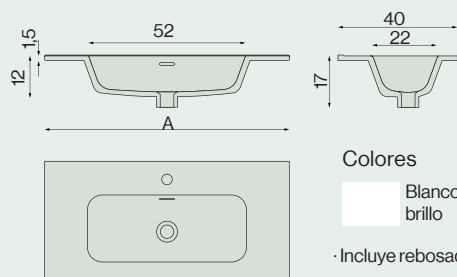

#### Colores

Blanco  
brillo

· Incluye rebosadero

#### POSICIÓN DE LAVABO

A (cm)

E (cm)

REF

PVP

#### CENTRADO

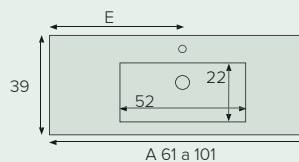

61	30	EC.061.R	-
71	35	EC.071.R	-
81	45	EC.081.R	-
101	50	EC.101.R	-

### GLASS BLANCO

### GLASS BLANCO

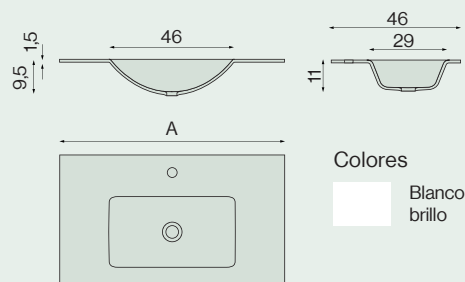

### POSICIÓN DE LAVABO

A (cm) E(cm)

REF

PVP

#### CENTRADO

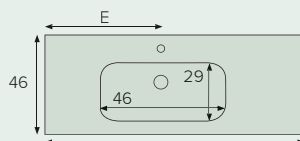

<b>61</b>	30	EL.061.C	-
<b>71</b>	35	EL.071.C	-
<b>81</b>	40	EL.081.C	-
<b>91</b>	45	EL.091.C	-
<b>101</b>	50	EL.101.C	-
<b>121</b>	60	EL.121.C	-

#### IZQUIERDO

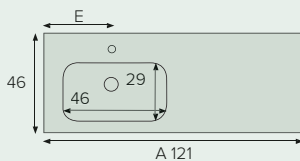

<b>121</b>	40	EL.121.I	-
------------	----	----------	---

#### DOBLE

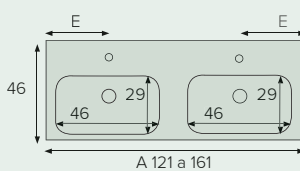

<b>121</b>	30	EL.121.X	-
<b>141</b>	35	EL.141.X	-
<b>161</b>	40	EL.161.X	-

**& complementa**

Válvulas y sifones  
página 292

### SOLID MINERAL

#### HARD

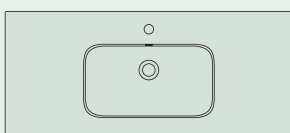
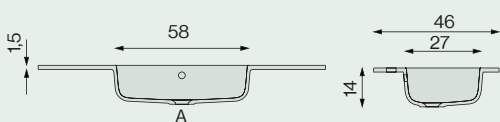

Colores

- Blanco brillo
- Blanco mate

· Incluye rebosadero

#### POSICIÓN DE LAVABO

A (cm) E (cm) Mate Brillo PVP

#### CENTRADO

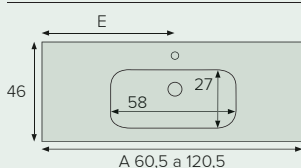

60,5	30	EH.061.CM	EH.061.CB	-
70,5	35	EH.071.CM	EH.071.CB	-
80,5	40	EH.081.CM	EH.081.CB	-
90,5	45	EH.091.CM	EH.091.CB	-
100,5	50	EH.101.CM	EH.101.CB	-
120,5	60	EH.121.CM	EH.121.CB	-

#### IZQUIERDO

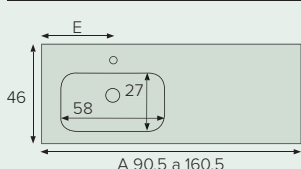

90,5	30	EH.091.IM	EH.091.IB	-
100,5	30	EH.101.IM	EH.101.IB	-
120,5	40	EH.121.IM	EH.121.IB	-
140,5	35	EH.141.IM	EH.141.IB	-
160,5	40	EH.161.IM	EH.161.IB	-

#### DERECHO

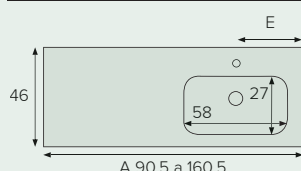

90,5	30	EH.091.DM	EH.091.DB	-
100,5	30	EH.101.DM	EH.101.DB	-
120,5	40	EH.121.DM	EH.121.DB	-
140,5	35	EH.141.DM	EH.141.DB	-
160,5	40	EH.161.DM	EH.161.DB	-

#### DOBLE

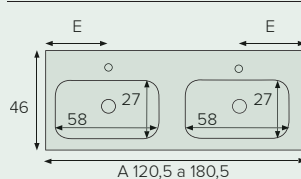

120,5	30	EH.121.XM	EH.121.XB	-
140,5	35	EH.141.XM	EH.141.XB	-
160,5	40	EH.161.XM	EH.161.XB	-
180,5	45	EH.181.XM	EH.181.XB	-

· Para encimera de 60,5 y de 120,5 y 140,5 doble, el lavabo es de 48 cm de ancho

#### MUR

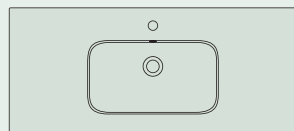
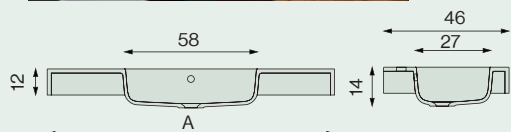
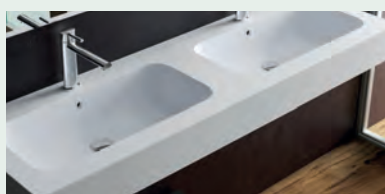

Colores

- Blanco brillo
- Blanco mate

· Soportes incluidos  
· Incluye rebosadero

#### POSICIÓN DE LAVABO

A (cm) E (cm) Mate Brillo PVP

#### CENTRADO

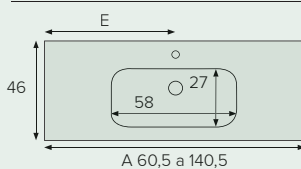

60,5	30	EM.061.CM	EM.061.CB	-
70,5	35	EM.071.CM	EM.071.CB	-
80,5	40	EM.081.CM	EM.081.CB	-
90,5	45	EM.091.CM	EM.091.CB	-
100,5	50	EM.101.CM	EM.101.CB	-
120,5	60	EM.121.CM	EM.121.CB	-
140,5	60	EM.141.CM	EM.141.CB	-

#### IZQUIERDO

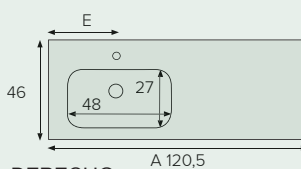

120,5	30	EM.121.IM	EM.121.IB	-
-------	----	-----------	-----------	---

#### DERECHO

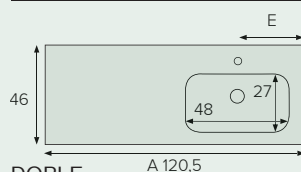

120,5	30	EM.121.DM	EM.121.DB	-
-------	----	-----------	-----------	---

#### DOBLE

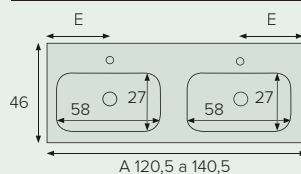

120,5	30	EM.121.XM	EM.121.XB	-
140,5	35	EM.141.XM	EM.141.XB	-

· Para encimera de 60,5 y de 120,5 doble, el lavabo es de 48 cm de ancho



### SOLID MINERAL

#### PRISMA

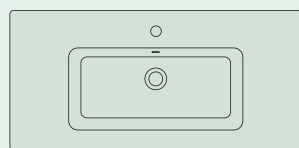
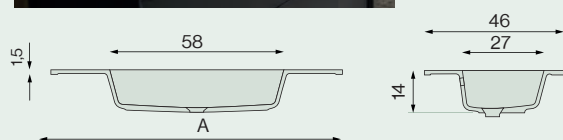
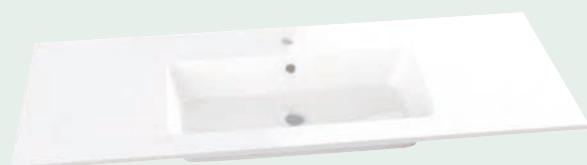

#### Colores

- Blanco brillo
- Blanco mate

· Incluye rebosadero

POSICIÓN DE LAVABO	A (cm)	E(cm)	Mate	Brillo	PVP
--------------------	--------	-------	------	--------	-----

#### CENTRADO

	60,5	30	EP061.CM	EP061.CB	-
	80,5	40	EP081.CM	EP081.CB	-
	90,5	45	EP091.CM	EP091.CB	-
	100,5	50	EP101.CM	EP101.CB	-
	120,5	60	EP121.CM	EP121.CB	-

A 60,5 a 120,5

#### IZQUIERDO

	120,5	30	EP121.IM	EP121.IB	-
--	-------	----	----------	----------	---

A 120,5

#### DERECHO

	120,5	30	EP121.DM	EP121.DB	-
--	-------	----	----------	----------	---

A 120,5

#### DOBLE

	120,5	30	EP121.XM	EP121.XB	-
	140,5	35	EP141.XM	EP141.XB	-

A 120,5 a 140,5

· Para encimera de 60,5 y de 120,5 doble el lavabo es de 48 cm de ancho

#### WALL

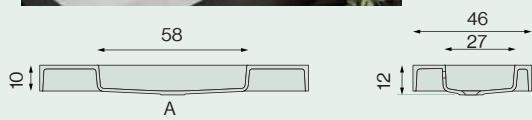

#### Colores

- Blanco brillo
- Blanco mate

· Incluye rebosadero  
· Soportes incluidos

POSICIÓN DE LAVABO	A (cm)	E(cm)	Mate	Brillo	PVP
--------------------	--------	-------	------	--------	-----

#### CENTRADO

	60,5	30	EA.061.CM	EA.061.CB	-
	80,5	40	EA.081.CM	EA.081.CB	-
	90,5	45	EA.091.CM	EA.091.CB	-
	100,5	50	EA.101.CM	EA.101.CB	-
	120,5	60	EA.121.CM	EA.121.CB	-

A 60,5 a 120,5

#### DOBLE

	120,5	30	EA.121.XM	EA.121.XB	-
	140,5	35	EA.141.XM	EA.141.XB	-

A 120,5 a 140,5

· Para encimera de 60,5 y de 120,5 doble, el lavabo es de 48 cm de ancho

#### & complementa

Válvulas y sifones  
página 292

### SOLID MINERAL

#### WAVE

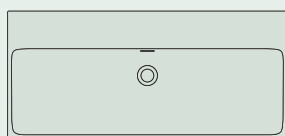
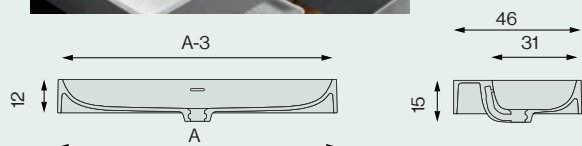

#### Colores

- Blanco brillo
- Blanco mate

#### POSICIÓN DE LAVABO

A (cm) E(cm)

Mate

Brillo

PVP

#### CENTRADO

A (cm)	E (cm)	Mate	Brillo	PVP
60,5	30	EW.061.CM	EW.061.CB	-
70,5	35	EW.071.CM	EW.071.CB	-
80,5	40	EW.081.CM	EW.081.CB	-
90,5	45	EW.091.CM	EW.091.CB	-
100,5	50	EW.101.CM	EW.101.CB	-

#### DOBLE

A (cm)	E (cm)	Mate	Brillo	PVP
120,5	30	EW.121.XM	EW.121.XB	-

- Perfil de 1,5 cm de grosor
- Incluye rebosadero
- Incluye soportes de fijación a pared

#### THIN

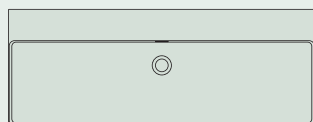
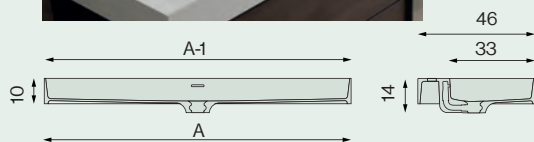
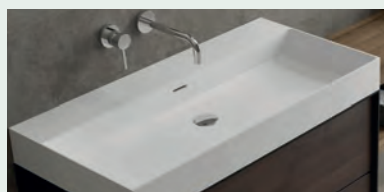

#### Colores

- Blanco mate

#### POSICIÓN DE LAVABO

A (cm) E(cm)

Mate

PVP

#### CENTRADO

A (cm)	E (cm)	Mate	PVP
60,5	30	ET.061.CM	-
70,5	35	ET.071.CM	-
80,5	40	ET.081.CM	-
90,5	45	ET.091.CM	-
100,5	50	ET.101.CM	-
120,5	60	ET.121.CM	-

- Perfil de 0,5 cm de grosor
- Incluye rebosadero
- Incluye soportes de fijación a pared

### SOLID MINERAL

#### FLY

POSICIÓN DE LAVABO	A (cm)	E (cm)	Mate	Brillo	PVP
--------------------	--------	--------	------	--------	-----

#### CENTRADO

	<b>60,5</b>	30	EF.061.CM	EF.061.CB	-
	<b>70,5</b>	35	EF.071.CM	EF.071.CB	-
	<b>80,5</b>	40	EF.081.CM	EF.081.CB	-
	<b>90,5</b>	45	EF.091.CM	EF.091.CB	-
	<b>100,5</b>	50	EF.101.CM	EF.101.CB	-
	<b>120,5</b>	60	EF.121.CM	EF.121.CB	-

#### IZQUIERDO

	<b>120,5</b>	30	EF.121.IM	EF.121.IB	-
--	--------------	----	-----------	-----------	---

#### DERECHO

	<b>120,5</b>	30	EF.121.DM	EF.121.DB	-
--	--------------	----	-----------	-----------	---

#### DOBLE

	<b>120,5</b>	30	EF.121.XM	EF.121.XB	-
	<b>140,5</b>	35	EF.141.XM	EF.141.XB	-

· Para encimera de 60,5 cm y encimera doble de 120,5 el lavabo es de 50,5 - 35 cm

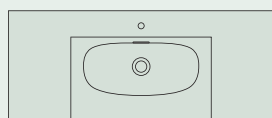
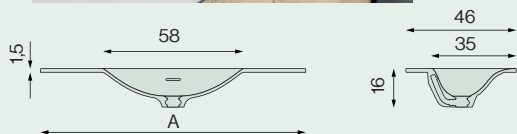
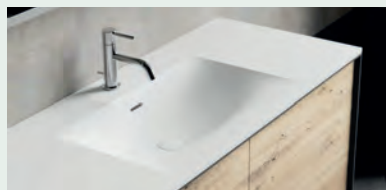

#### Colores

- Blanco brillo
- Blanco mate

#### HUG



POSICIÓN DE DECORATIVO	A (cm)	E (cm)	Mate	PVP
------------------------	--------	--------	------	-----

#### DERECHO

	<b>90</b>	50	EG.090.DM	-
	<b>110</b>	60	EG.110.DM	-
	<b>130</b>	70	EG.130.DM	-

#### IZQUIERDO

	<b>90</b>	50	EG.090.IM	-
	<b>110</b>	60	EG.110.IM	-
	<b>130</b>	70	EG.130.IM	-

#### Colores

- Blanco mate

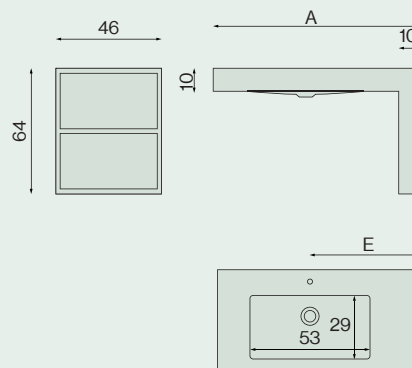

- Es posible pedir la encimera sin orificio de grifo
- Otros diseños especiales disponibles

#### & complementa

Válvulas y sifones  
página 292

### SOLID MINERAL

#### PERSONALIZA Y CONFIGURA A MEDIDA

Selecciona medida, grosor y añade el lavabo deseado.



#### Colores

Blanco mate

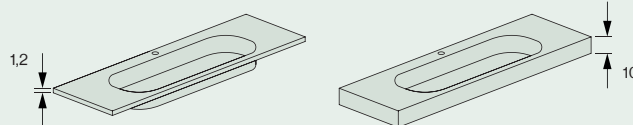

POSICIÓN DE LAVABO	A (cm)	E(cm)	REF	PVP	REF	PVP
<b>CENTRADO</b>						
	61	30	ES.061.CP	-	ES.061.CM	-
	71	35	ES.071.CP	-	ES.071.CM	-
	81	40	ES.081.CP	-	ES.081.CM	-
	91	45	ES.091.CP	-	ES.091.CM	-
	101	50	ES.101.CP	-	ES.101.CM	-
	121	60	ES.121.CP	-	ES.121.CM	-
	141	70	ES.141.CP	-	ES.141.CM	-
	161	80	ES.161.CP	-	ES.161.CM	-
	181	90	ES.181.CP	-	ES.181.CM	-
201	100	ES.201.CP	-	ES.201.CM	-	
<b>IZQUIERDO</b>						
	91	30	ES.091.IP	-	ES.091.IM	-
	101	35	ES.101.IP	-	ES.101.IM	-
	121	40	ES.121.IP	-	ES.121.IM	-
	141	35	ES.141.IP	-	ES.141.IM	-
	161	40	ES.161.IP	-	ES.161.IM	-
	181	45	ES.181.IP	-	ES.181.IM	-
201	50	ES.201.IP	-	ES.201.IM	-	
<b>DERECHO</b>						
	91	30	ES.091.DP	-	ES.091.DM	-
	101	35	ES.101.DP	-	ES.101.DM	-
	121	40	ES.121.DP	-	ES.121.DM	-
	141	35	ES.141.DP	-	ES.141.DM	-
	161	40	ES.161.DP	-	ES.161.DM	-
	181	45	ES.181.DP	-	ES.181.DM	-
201	50	ES.201.DP	-	ES.201.DM	-	
<b>DOBLE</b>						
	121	30	ES.121.XP	-	ES.121.XM	-
	141	35	ES.141.XP	-	ES.141.XM	-
	161	40	ES.161.XP	-	ES.161.XM	-
	181	45	ES.181.XP	-	ES.181.XM	-
	201	50	ES.201.XP	-	ES.201.XM	-



#### MEDIDAS ESPECIALES

Es posible pedir sin sobreprecio:

- Anchos especiales. Precio de la medida superior.
- Alto de faldón de 5 a 10 cm.

#### ORIFICIO DE GRIFO Y LAVABO

- Es posible pedir la encimera sin orificio de grifo.
- Eje de lavabo según necesidad.
- Disponible con rebosadero.

#### & complementa

Válvulas y sifones,  
Soportes encimera,  
Toalleros, Zócalos  
páginas 292-293

### LAVABOS A ESCOGER

#### MINI



#### OBI

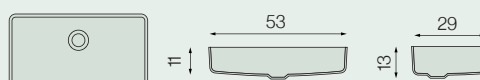

#### LIENA

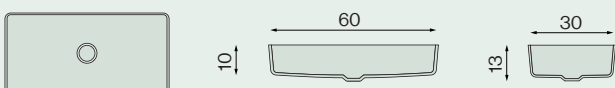

- Disponible en encimeras a partir de 70 cm.
- Disponible en encimeras dobles a partir de 140 cm.

#### AMUR

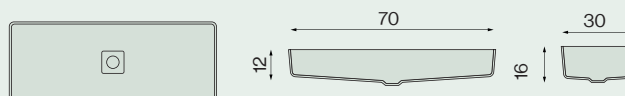

- Disponible en encimeras a partir de 80 cm.
- Disponible en encimeras dobles a partir de 160 cm.

#### VOIGA

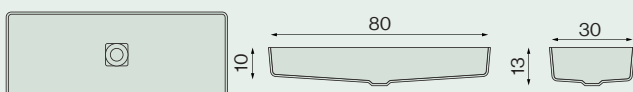

- Disponible en encimeras a partir de 90 cm.
- Disponible en encimeras dobles a partir de 180 cm.

#### SKYE

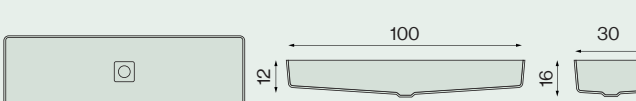

- Disponible en encimeras a partir de 110 cm.
- No disponible en encimeras dobles.

#### OVAL

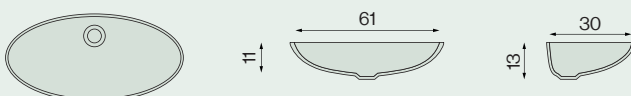

- Disponible en encimeras a partir de 70 cm.
- Disponible en encimeras dobles a partir de 140 cm.

#### EXTRA KIT REBOSADERO



REF	PVP
CE29	-

SOLID SURFACE 

### PERSONALIZA Y CONFIGURA A MEDIDA

Selecciona medida, grosor y añade el lavabo deseado.



#### Colores

 Blanco mate

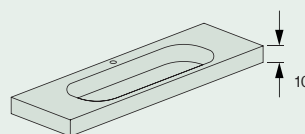
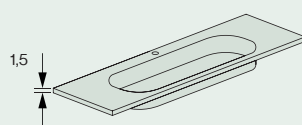

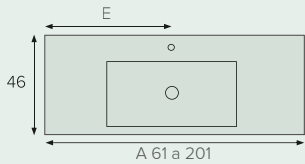
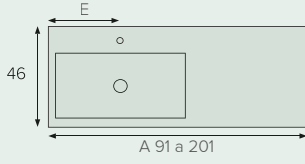
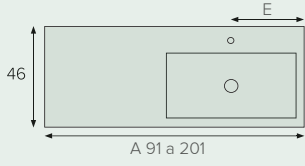
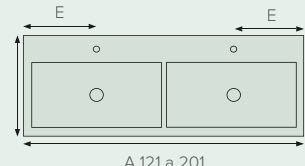
POSICIÓN DE LAVABO	A (cm)	E (cm)	REF	PVP	REF	PVP
<b>CENTRADO</b>						
	61	30	EJ.061.CP	-	EJ.061.CM	-
	71	35	EJ.071.CP	-	EJ.071.CM	-
	81	40	EJ.081.CP	-	EJ.081.CM	-
	91	45	EJ.091.CP	-	EJ.091.CM	-
	101	50	EJ.101.CP	-	EJ.101.CM	-
	121	60	EJ.121.CP	-	EJ.121.CM	-
	141	70	EJ.141.CP	-	EJ.141.CM	-
	161	80	EJ.161.CP	-	EJ.161.CM	-
	181	90	EJ.181.CP	-	EJ.181.CM	-
201	100	EJ.201.CP	-	EJ.201.CM	-	
<b>IZQUIERDO</b>						
	91	30	EJ.091.IP	-	EJ.091.IM	-
	101	35	EJ.101.IP	-	EJ.101.IM	-
	121	40	EJ.121.IP	-	EJ.121.IM	-
	141	35	EJ.141.IP	-	EJ.141.IM	-
	161	40	EJ.161.IP	-	EJ.161.IM	-
	181	45	EJ.181.IP	-	EJ.181.IM	-
201	50	EJ.201.IP	-	EJ.201.IM	-	
<b>DERECHO</b>						
	91	30	EJ.091.DP	-	EJ.091.DM	-
	101	35	EJ.101.DP	-	EJ.101.DM	-
	121	40	EJ.121.DP	-	EJ.121.DM	-
	141	35	EJ.141.DP	-	EJ.141.DM	-
	161	40	EJ.161.DP	-	EJ.161.DM	-
	181	45	EJ.181.DP	-	EJ.181.DM	-
201	50	EJ.201.DP	-	EJ.201.DM	-	
<b>DOBLE</b>						
	121	30	EJ.121.XP	-	EJ.121.XM	-
	141	35	EJ.141.XP	-	EJ.141.XM	-
	161	40	EJ.161.XP	-	EJ.161.XM	-
	181	45	EJ.181.XP	-	EJ.181.XM	-
	201	50	EJ.201.XP	-	EJ.201.XM	-



#### MEDIDAS ESPECIALES

Es posible pedir sin sobreprecio:

- Anchos especiales. Precio de la medida superior.
- Alto de faldón de 5 a 10 cm.

#### ORIFICIO DE GRIFO Y LAVABO

- Es posible pedir la encimera sin orificio de grifo.
- Eje de lavabo según necesidad.
- Disponible con rebosadero.

#### & complementa

Válvulas y sifones,  
Soportes encimera,  
Toalleros, Zócalos  
páginas 292-293

### LAVABOS A ESCOGER

#### VICTORIA

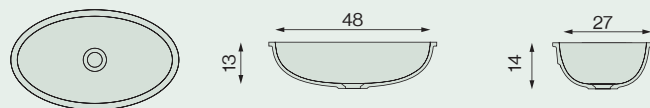

#### ONTARIO

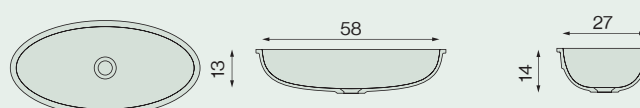

- Disponible en encimeras a partir de 70 cm.
- Disponible en encimeras dobles a partir de 140 cm.

#### BAIKAL

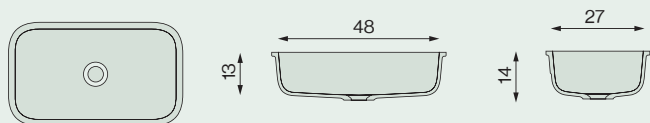

#### NYASSA

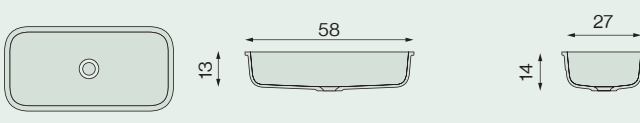

- Disponible en encimeras a partir de 70 cm.
- Disponible en encimeras dobles a partir de 140 cm.

#### NESS

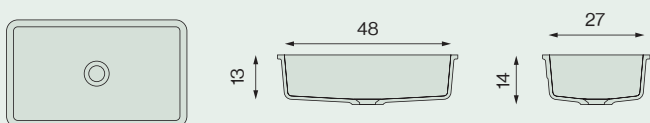

#### ERIE

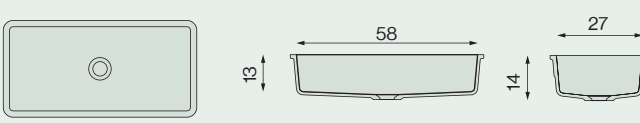
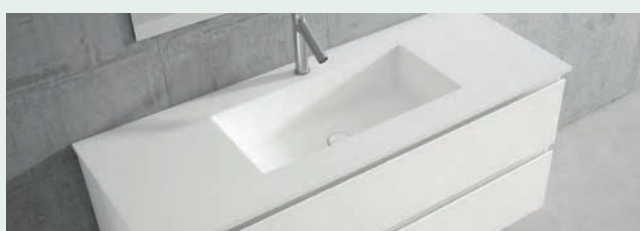

- Disponible en encimeras a partir de 70 cm.
- Disponible en encimeras dobles a partir de 140 cm.

#### NASSER

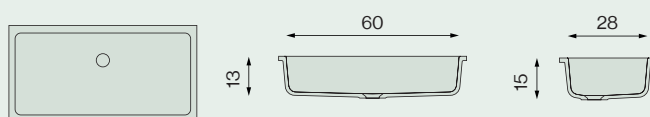

- Disponible en encimeras a partir de 70 cm.
- Disponible en encimeras dobles a partir de 140 cm.

#### EXTRA KIT REBOSADERO



REF	PVP
CE30	-

### PIEDRA NATURAL

#### PERSONALIZA Y CONFIGURA A MEDIDA

Selecciona medida, grosor y añade el lavabo deseado.



#### Colores

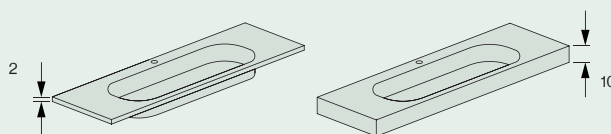
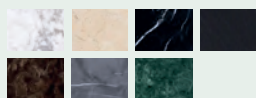

POSICIÓN DE LAVABO	A (cm)	E(cm)	REF	PVP	REF	PVP
<b>CENTRADO</b>						
	61	30	EQ.061.CP	-	EQ.061.CM	-
	71	35	EQ.071.CP	-	EQ.071.CM	-
	81	40	EQ.081.CP	-	EQ.081.CM	-
	91	45	EQ.091.CP	-	EQ.091.CM	-
	101	50	EQ.101.CP	-	EQ.101.CM	-
	121	60	EQ.121.CP	-	EQ.121.CM	-
	141	70	EQ.141.CP	-	EQ.141.CM	-
	161	80	EQ.161.CP	-	EQ.161.CM	-
	181	90			EQ.181.CM	-
	201	100			EQ.201.CM	-
<b>IZQUIERDO</b>						
	91	30	EQ.091.IP	-	EQ.091.IM	-
	101	35	EQ.101.IP	-	EQ.101.IM	-
	121	40	EQ.121.IP	-	EQ.121.IM	-
	141	35	EQ.141.IP	-	EQ.141.IM	-
	161	40	EQ.161.IP	-	EQ.161.IM	-
	181	45			EQ.181.IM	-
<b>DERECHO</b>						
	91	30	EQ.091.DP	-	EQ.091.DM	-
	101	35	EQ.101.DP	-	EQ.101.DM	-
	121	40	EQ.121.DP	-	EQ.121.DM	-
	141	35	EQ.141.DP	-	EQ.141.DM	-
	161	40	EQ.161.DP	-	EQ.161.DM	-
	181	45			EQ.181.DM	-
<b>DOBLE</b>						
	121	30	EQ.121.XP	-	EQ.121.XM	-
	141	35	EQ.141.XP	-	EQ.141.XM	-
	161	40	EQ.161.XP	-	EQ.161.XM	-
	181	45	EQ.181.XP	-	EQ.181.XM	-
	201	50			EQ.201.XM	-



#### MEDIDAS ESPECIALES

Es posible pedir sin sobreprecio:

- Anchos especiales. Precio de la medida superior.
- Alto de faldón de 5 a 10 cm.

#### ORIFICIO DE GRIFO Y LAVABO

- Es posible pedir la encimera sin orificio de grifo.

#### & complementa

Válvulas y sifones,  
Soportes encimera,  
Toalleros, Zócalos  
páginas 292-293



LAVABOS A ESCOGER

PLUS

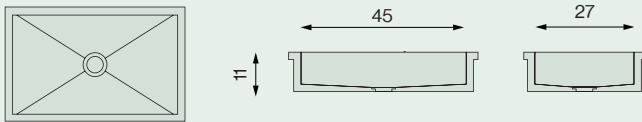

REGATA

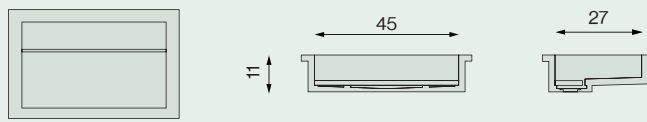

FALL

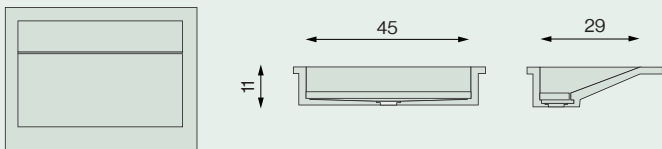

### CRISTALCOLOR

#### PERSONALIZA Y CONFIGURA A MEDIDA

Selecciona medida y añade el lavabo deseado.



#### Colores

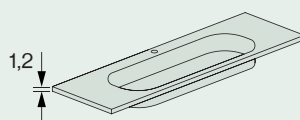

POSICIÓN DE LAVABO	A (cm)	E(cm)	REF	PVP
--------------------	--------	-------	-----	-----

#### CENTRADO

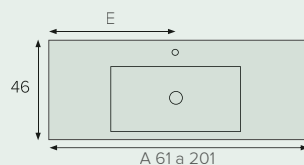

61	30	EK.061.CP	-
71	35	EK.071.CP	-
81	40	EK.081.CP	-
91	45	EK.091.CP	-
101	50	EK.101.CP	-
121	60	EK.121.CP	-
141	70	EK.141.CP	-
161	80	EK.161.CP	-
181	90	EK.181.CP	-
201	100	EK.201.CP	-

#### IZQUIERDO

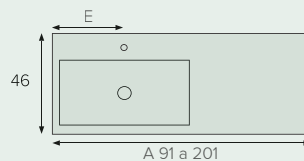

91	30	EK.091.IP	-
101	35	EK.101.IP	-
121	40	EK.121.IP	-
141	35	EK.141.IP	-
161	40	EK.161.IP	-
181	45	EK.181.IP	-
201	50	EK.201.IP	-

#### DERECHO

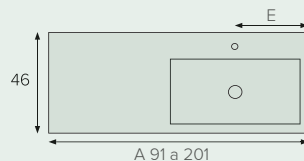

91	30	EK.091.DP	-
101	35	EK.101.DP	-
121	40	EK.121.DP	-
141	35	EK.141.DP	-
161	40	EK.161.DP	-
181	45	EK.181.DP	-
201	50	EK.201.DP	-

#### DOBLE

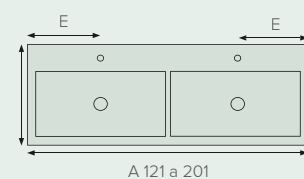

141	35	EK.141.XP	-
161	45	EK.161.XP	-
181	45	EK.181.XP	-
201	50	EK.201.XP	-



#### MEDIDAS ESPECIALES

Es posible pedir sin sobreprecio:

- Anchos especiales. Precio de la medida superior.
- Alto de faldón de 5 a 10 cm.

#### ORIFICIO DE GRIFO Y LAVABO

- Es posible pedir la encimera sin orificio de grifo.

#### COLOR ESPECIAL

- Es posible pedir color especial en carta RAL.

#### & complementa

Válvulas y sifones,  
página 292

### LAVABOS A ESCOGER

#### FLOW

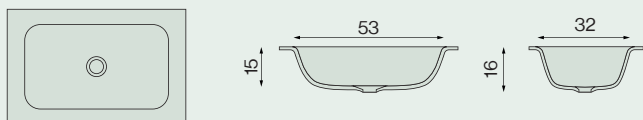

#### CANALE

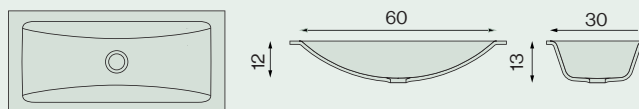

- Disponible en encimeras a partir de 70 cm.
- No disponible en encimeras de doble lavabo.

#### SEA

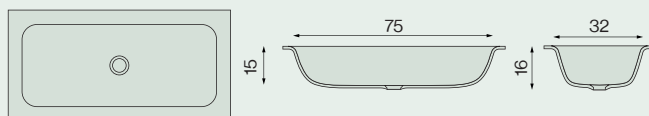

- Disponible en encimeras a partir de 80 cm.
- En lavabos dobles disponible en 180 y 200 cm.

### CERÁMICA / CERAMCOLOR

#### RECTÁNGULO



Colores

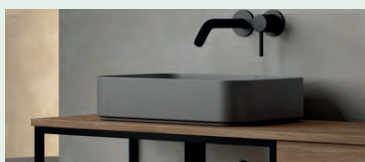

COLOR	REF	PVP
Blanco Brillo	LR.WB	-
Blanco Mate	LR.WM	-
Negro Mate	LR.BK	-
Tierra Mate	LR.TR	-
Cuarzo Mate	LR.CZ	-
Acero Mate	LR.AC	-
Antracita Mate	LR.AN	-
Oliva Mate	LR.VO	-

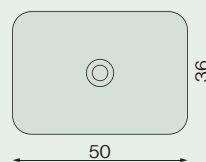

#### CUADRO



Colores



COLOR	REF	PVP
Blanco Brillo	LC.WB	-
Blanco Mate	LC.WM	-
Negro Mate	LC.BK	-
Tierra Mate	LC.TR	-
Cuarzo Mate	LC.CZ	-
Acero Mate	LC.AC	-
Antracita Mate	LC.AN	-
Oliva Mate	LC.VO	-

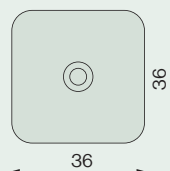
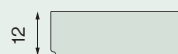

#### SQUARE



Colores

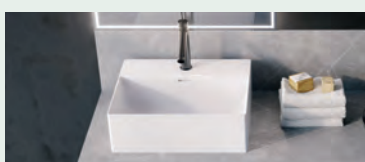

COLOR	REF	PVP
Blanco Brillo	LS.WB	-
Blanco Mate	LS.WM	-
Negro Mate	LS.BK	-
Tierra Mate	LS.TR	-
Cuarzo Mate	LS.CZ	-
Acero Mate	LS.AC	-
Antracita Mate	LS.AN	-
Oliva Mate	LS.VO	-

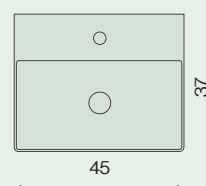
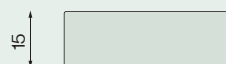

CERÁMICA / CERAMCOLOR

ÓVALO



Colores



COLOR	REF	PVP
Blanco Brillo	LVWB	-
Blanco Mate	LVWM	-
Negro Mate	LV.BK	-
Tierra Mate	LV.TR	-
Cuarzo Mate	LVCZ	-
Acero Mate	LV.AC	-
Antracita Mate	LV.AN	-
Oliva Mate	LVVO	-

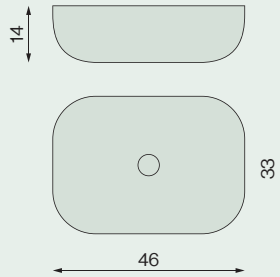

CIRCUS



Colores



COLOR	REF	PVP
Blanco Brillo	LUWB	-
Blanco Mate	LUWM	-
Negro Mate	LUBK	-
Tierra Mate	LU.TR	-
Cuarzo Mate	LUCZ	-
Acero Mate	LU.AC	-
Antracita Mate	LU.AN	-
Oliva Mate	LUVO	-

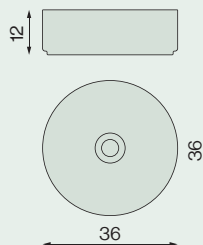

EYE



Colores



COLOR	REF	PVP
Blanco Mate	LYWM	-
Negro Mate	LY.BK	-
Tierra Mate	LY.TR	-
Cuarzo Mate	LY.CZ	-
Acero Mate	LY.AC	-
Antracita Mate	LY.AN	-
Oliva Mate	LYVO	-

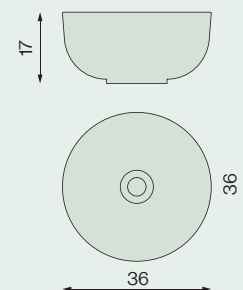

**& complementa**

Válvulas y sifones,  
Encimeras planas  
página 292

**MICROCEMENTO**

**CEMBAS**



COLOR	REF	PVP
-------	-----	-----

Microcemento	LP	-
--------------	----	---

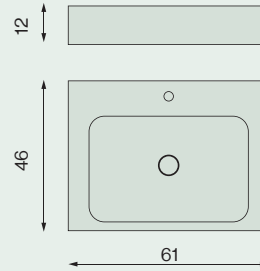

**CEMBOWL**



COLOR	REF	PVP
-------	-----	-----

Microcemento	LW	-
--------------	----	---

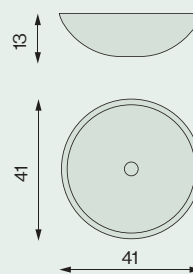

**ACERO INOXIDABLE**

**METALCIRCUS**



Colores

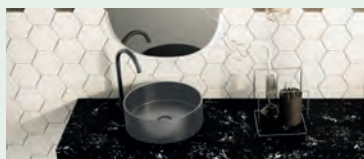

COLOR	REF	PVP
-------	-----	-----

Acero Inoxidable	LM.AC	-
Antracita	LM.AN	-

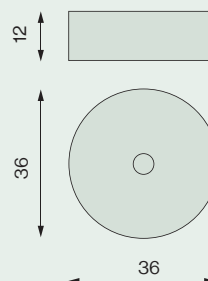

### ACERO INOXIDABLE

#### METALSQUARE



Colores



COLOR	REF	PVP
Acero Inoxidable	LQ.AC	-
Antracita	LQ.AN	-

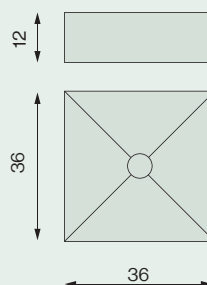

### PIEDRA NATURAL

#### PIETRA



Colores

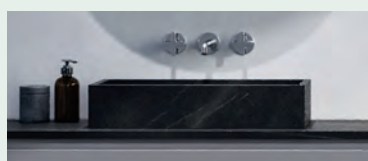
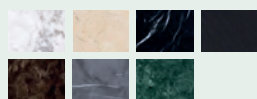

COLOR	REF	PVP
Negro Marquina	LT.N	-
Carrara	LTC	-
Verde India	LTV	-
Marrón Imperial	LT.MI	-
Crema Marfil	LT.CM	-
Pietra Gris	LT.PG	-

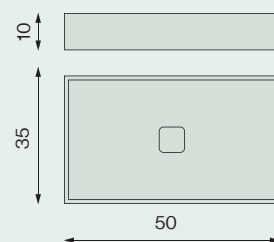

#### & complementa

Válvulas y sifones,  
Encimeras planas  
página 292

SOLID SURFACE 

### PRIM



Colores

 Blanco mate



A (cm)	REF	PVP
48	LK.048	-
58	LK.058	-

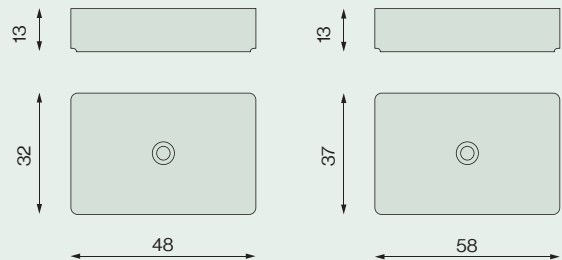

### CUADRA



Colores

 Blanco mate



COLOR	REF	PVP
Mate	LD	-

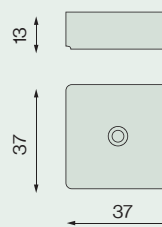

### CÍRCULO



Colores

 Blanco mate



COLOR	REF	PVP
Mate	LF	-

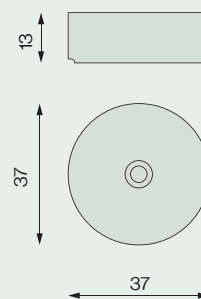



SOLID SURFACE 

**ROUND**



Colores

 Blanco mate



**COLOR**

**REF**

**PVP**

Mate

LZ

-

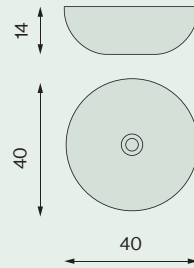

**ELIPTIC**



Colores

 Blanco mate



**COLOR**

**REF**

**PVP**

Mate

LH

-

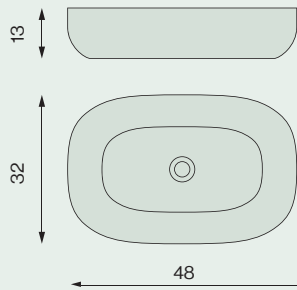

**MAX**



Colores

 Blanco mate



**COLOR**

**REF**

**PVP**

Mate

LA

-

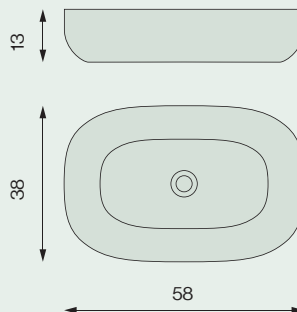

**& complementa**

Válvulas y sifones,  
Encimeras planas  
página 292

SOLID SURFACE 

**SMILE**



Colores

 Blanco mate

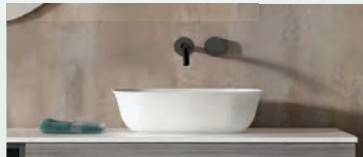

**COLOR**

**REF**

**PVP**

Mate

LX

-

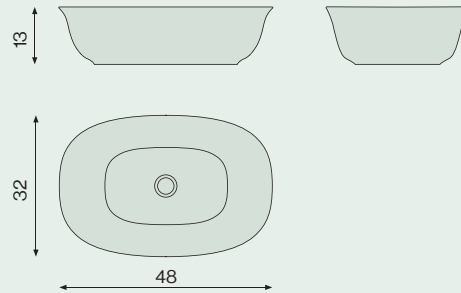

**COPA**



Colores

 Blanco mate



**COLOR**

**REF**

**PVP**

Mate

LG

-

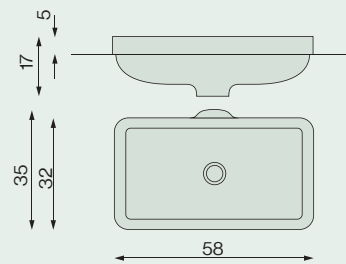

**& complementa**

Válvulas y sifones,  
Encimeras planas  
página 292

SOLID SURFACE 

**BALOON**



**POSICIÓN**

**REF**

**PVP**

Desagüe a suelo*	TB.S	-
Desagüe a pared	TB.P	-

\*incluye drenaje de desagüe

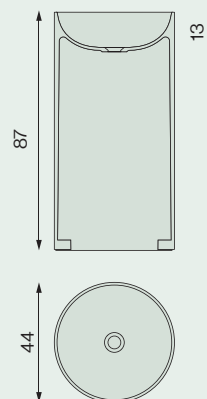

**Colores**

 Blanco mate

**PILLAR**



**POSICIÓN**

**REF**

**PVP**

Desagüe a suelo*	TL.S	-
Desagüe a pared	TL.P	-

\*incluye drenaje de desagüe

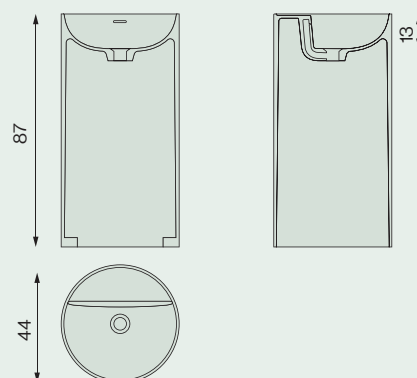

**Colores**

 Blanco mate

**COLUMN**



**POSICIÓN**

**REF**

**PVP**

Desagüe a suelo*	TC.S	-
Desagüe a pared	TC.P	-

\*incluye drenaje de desagüe

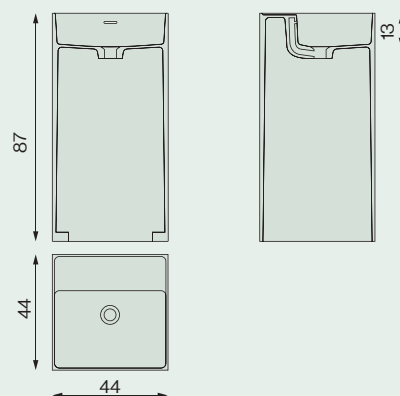

**Colores**

 Blanco mate

### MADERA NATURE



#### Colores

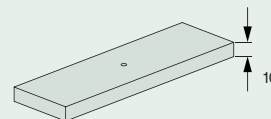
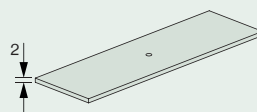
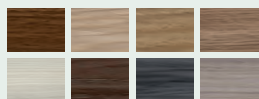

POSICIÓN DEL LAVABO	A (cm)	E(cm)	REF	PVP	REF	PVP	
<b>CENTRADO</b>							
	A 61 a 201	<b>61</b>	30	PN.061.CP	-	PN.061.CM	-
		<b>71</b>	35	PN.071.CP	-	PN.071.CM	-
		<b>81</b>	40	PN.081.CP	-	PN.081.CM	-
		<b>91</b>	45	PN.091.CP	-	PN.091.CM	-
		<b>101</b>	50	PN.101.CP	-	PN.101.CM	-
		<b>121</b>	60	PN.121.CP	-	PN.121.CM	-
		<b>141</b>	70	PN.141.CP	-	PN.141.CM	-
		<b>161</b>	80	PN.161.CP	-	PN.161.CM	-
		<b>181</b>	90	PN.181.CP	-	PN.181.CM	-
		<b>201</b>	100	PN.201.CP	-	PN.201.CM	-
<b>IZQUIERDO</b>							
	A 91 a 201	<b>91</b>	30	PN.091.IP	-	PN.091.IM	-
		<b>101</b>	35	PN.101.IP	-	PN.101.IM	-
		<b>121</b>	40	PN.121.IP	-	PN.121.IM	-
		<b>141</b>	40	PN.141.IP	-	PN.141.IM	-
		<b>161</b>	40	PN.161.IP	-	PN.161.IM	-
		<b>181</b>	45	PN.181.IP	-	PN.181.IM	-
<b>DERECHO</b>							
	A 91 a 201	<b>91</b>	30	PN.091.DP	-	PN.091.DM	-
		<b>101</b>	35	PN.101.DP	-	PN.101.DM	-
		<b>121</b>	40	PN.121.DP	-	PN.121.DM	-
		<b>141</b>	40	PN.141.DP	-	PN.141.DM	-
		<b>161</b>	40	PN.161.DP	-	PN.161.DM	-
		<b>181</b>	45	PN.181.DP	-	PN.181.DM	-
<b>DOBLE</b>							
	A 121 a 201	<b>121</b>	30	PN.121.XP	-	PN.121.XM	-
		<b>141</b>	35	PN.141.XP	-	PN.141.XM	-
		<b>161</b>	40	PN.161.XP	-	PN.161.XM	-
		<b>181</b>	45	PN.181.XP	-	PN.181.XM	-
	<b>201</b>	50	PN.201.XP	-	PN.201.XM	-	



#### MEDIDAS ESPECIALES

Es posible pedir sin sobreprecio:

- Anchos especiales. Precio de la medida superior

- Fondo reducido a 40 cm

- Alto de faldón de 5 a 10 cm

#### ORIFICIO DE GRIFO Y LAVABO

Se puede pedir:

- Sin orificio de lavabo y/o grifo

- Eje de lavabo según necesidad

- Mecanizado de lavabo especial fuera de catálogo

#### & complementa

Válvulas y sifones,  
Soportes encimera  
página 292

### LACA

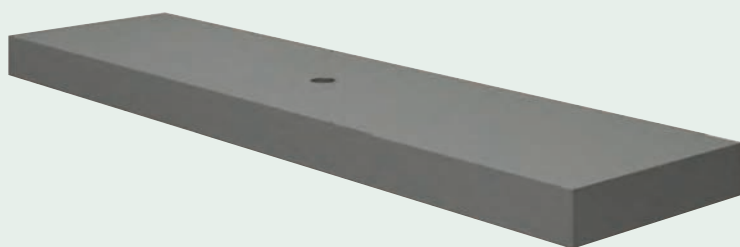
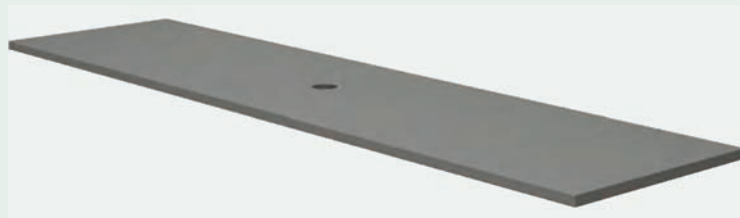

#### Colores

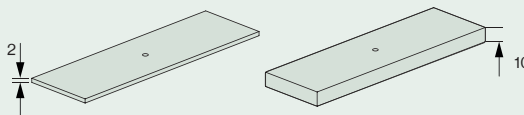

POSICIÓN DEL LAVABO	A (cm)	E(cm)	REF	PVP	REF	PVP
<b>CENTRADO</b>						
	A 61 a 201					
	61	30	PL.061.CP	-	PL.061.CM	-
	71	35	PL.071.CP	-	PL.071.CM	-
	81	40	PL.081.CP	-	PL.081.CM	-
	91	45	PL.091.CP	-	PL.091.CM	-
	101	50	PL.101.CP	-	PL.101.CM	-
	121	60	PL.121.CP	-	PL.121.CM	-
	141	70	PL.141.CP	-	PL.141.CM	-
	161	80	PL.161.CP	-	PL.161.CM	-
	181	90	PL.181.CP	-	PL.181.CM	-
201	100	PL.201.CP	-	PL.201.CM	-	
<b>IZQUIERDO</b>						
	A 91 a 201					
	91	30	PL.091.IP	-	PL.091.IM	-
	101	35	PL.101.IP	-	PL.101.IM	-
	121	40	PL.121.IP	-	PL.121.IM	-
	141	40	PL.141.IP	-	PL.141.IM	-
	161	40	PL.161.IP	-	PL.161.IM	-
	181	45	PL.181.IP	-	PL.181.IM	-
201	50	PL.201.IP	-	PL.201.IM	-	
<b>DERECHO</b>						
	A 91 a 201					
	91	30	PL.091.DP	-	PL.091.DM	-
	101	35	PL.101.DP	-	PL.101.DM	-
	121	40	PL.121.DP	-	PL.121.DM	-
	141	40	PL.141.DP	-	PL.141.DM	-
	161	40	PL.161.DP	-	PL.161.DM	-
	181	45	PL.181.DP	-	PL.181.DM	-
201	50	PL.201.DP	-	PL.201.DM	-	
<b>DOBLE</b>						
	A 121 a 201					
	121	30	PL.121.XP	-	PL.121.XM	-
	141	40	PL.141.XP	-	PL.141.XM	-
	161	40	PL.161.XP	-	PL.161.XM	-
	181	45	PL.181.XP	-	PL.181.XM	-
201	50	PL.201.XP	-	PL.201.XM	-	



#### MEDIDAS ESPECIALES

Es posible pedir sin sobreprecio:

- Anchos especiales. Precio de la medida superior

- Fondo reducido a 40 cm

- Alto del faldón de 5 a 10 cm

#### ORIFICIO DE GRIFO Y LAVABO

Se puede pedir:

- Sin orificio de lavabo y/o grifo

- Eje de lavabo según necesidad

- Mecanizado de lavabo especial fuera de catálogo

#### & complementa



Válvulas y sifones, Soportes encimera página 292

### MADERA TABLERO MARINO / Chapa de Roble y Nogal

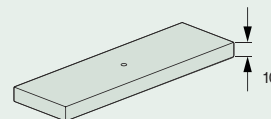
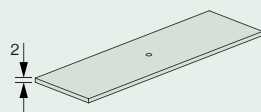
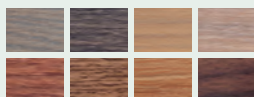

#### Colores

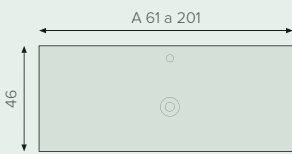
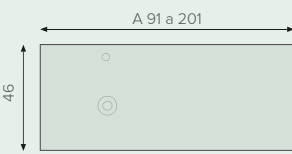
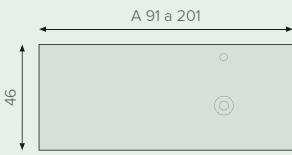

POSICIÓN DEL LAVABO	A (cm)	E(cm)	REF	PVP	REF	PVP	
<b>CENTRADO</b>							 <p><b>MEDIDAS ESPECIALES</b></p> <p>Es posible pedir sin sobreprecio:</p> <ul style="list-style-type: none"> <li>- Anchos especiales. Precio de la medida superior</li> <li>- Fondo reducido a 40 cm</li> <li>- Alto de faldón de 5 a 10 cm</li> </ul> <p><b>ORIFICIO DE GRIFO Y LAVABO</b></p> <p>Se puede pedir:</p> <ul style="list-style-type: none"> <li>- Sin orificio de lavabo y/o grifo</li> <li>- Eje de lavabo según necesidad</li> <li>- Mecanizado de lavabo especial fuera de catálogo</li> </ul>
	61	30	PT.061.CP	-	PT.061.CM	-	
	71	35	PT.071.CP	-	PT.071.CM	-	
	81	40	PT.081.CP	-	PT.081.CM	-	
	91	45	PT.091.CP	-	PT.091.CM	-	
	101	50	PT.101.CP	-	PT.101.CM	-	
	121	60	PT.121.CP	-	PT.121.CM	-	
	141	70	PT.141.CP	-	PT.141.CM	-	
	161	80	PT.161.CP	-	PT.161.CM	-	
	181	90	PT.181.CP	-	PT.181.CM	-	
201	100	PT.201.CP	-	PT.201.CM	-		
<b>IZQUIERDO</b>							
	91	30	PT.091.IP	-	PT.091.IM	-	
	101	35	PT.101.IP	-	PT.101.IM	-	
	121	40	PT.121.IP	-	PT.121.IM	-	
	141	40	PT.141.IP	-	PT.141.IM	-	
	161	40	PT.161.IP	-	PT.161.IM	-	
	181	45	PT.181.IP	-	PT.181.IM	-	
<b>DERECHO</b>							
	91	30	PT.091.DP	-	PT.091.DM	-	
	101	35	PT.101.DP	-	PT.101.DM	-	
	121	40	PT.121.DP	-	PT.121.DM	-	
	141	40	PT.141.DP	-	PT.141.DM	-	
	161	40	PT.161.DP	-	PT.161.DM	-	
	181	45	PT.181.DP	-	PT.181.DM	-	
<b>DOBLE</b>							
	121	30	PT.121.XP	-	PT.121.XM	-	
	141	35	PT.141.XP	-	PT.141.XM	-	
	161	40	PT.161.XP	-	PT.161.XM	-	
	181	45	PT.181.XP	-	PT.181.XM	-	
201	50	PT.201.XP	-	PT.201.XM	-		

#### & complementa

Válvulas y sifones,  
Soportes encimera  
página 292

### MADERA ROBLE MACIZO



#### Colores

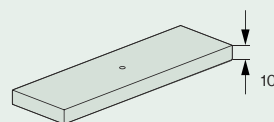
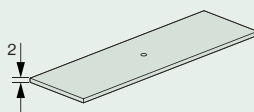
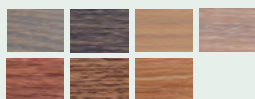

POSICIÓN DEL LAVABO	A (cm)	E(cm)	REF	PVP	REF	PVP		
<b>CENTRADO</b>							<p><b>MEDIDAS ESPECIALES</b></p> <p>Es posible pedir sin sobreprecio:</p> <ul style="list-style-type: none"> <li>- Anchos especiales. Precio de la medida superior</li> <li>- Fondo reducido a 40 cm</li> <li>- Alto de faldón de 5 a 10 cm</li> </ul> <p><b>ORIFICIO DE GRIFO Y LAVABO</b></p> <p>Se puede pedir:</p> <ul style="list-style-type: none"> <li>- Sin orificio de lavabo y/o grifo</li> <li>- Eje de lavabo según necesidad</li> <li>- Mecanizado de lavabo especial fuera de catálogo</li> </ul>	
	A 61 a 201	<b>61</b>	30	PZ.061.CP	-	PZ.061.CM		-
		<b>71</b>	35	PZ.071.CP	-	PZ.071.CM		-
		<b>81</b>	40	PZ.081.CP	-	PZ.081.CM		-
		<b>91</b>	45	PZ.091.CP	-	PZ.091.CM		-
		<b>101</b>	50	PZ.101.CP	-	PZ.101.CM		-
		<b>121</b>	60	PZ.121.CP	-	PZ.121.CM		-
		<b>141</b>	70	PZ.141.CP	-	PZ.141.CM		-
		<b>161</b>	80	PZ.161.CP	-	PZ.161.CM		-
	<b>181</b>	90	PZ.181.CP	-	PZ.181.CM	-		
	<b>201</b>	100	PZ.201.CP	-	PZ.201.CM	-		
<b>IZQUIERDO</b>								
	A 91 a 201	<b>91</b>	30	PZ.091.IP	-	PZ.091.IM		-
		<b>101</b>	35	PZ.101.IP	-	PZ.101.IM		-
		<b>121</b>	40	PZ.121.IP	-	PZ.121.IM		-
		<b>141</b>	40	PZ.141.IP	-	PZ.141.IM	-	
		<b>161</b>	40	PZ.161.IP	-	PZ.161.IM	-	
		<b>181</b>	45	PZ.181.IP	-	PZ.181.IM	-	
<b>DERECHO</b>								
	A 91 a 201	<b>91</b>	30	PZ.091.DP	-	PZ.091.DM	-	
		<b>101</b>	35	PZ.101.DP	-	PZ.101.DM	-	
		<b>121</b>	40	PZ.121.DP	-	PZ.121.DM	-	
		<b>141</b>	40	PZ.141.DP	-	PZ.141.DM	-	
		<b>161</b>	40	PZ.161.DP	-	PZ.161.DM	-	
		<b>181</b>	45	PZ.181.DP	-	PZ.181.DM	-	
<b>DOBLE</b>								
	A 121 a 201	<b>121</b>	30	PZ.121.XP	-	PZ.121.XM	-	
		<b>141</b>	35	PZ.141.XP	-	PZ.141.XM	-	
		<b>161</b>	40	PZ.161.XP	-	PZ.161.XM	-	
		<b>181</b>	45	PZ.181.XP	-	PZ.181.XM	-	
	<b>201</b>	50	PZ.201.XP	-	PZ.201.XM	-		

#### & complementa

Válvulas y sifones,  
Soportes encimera  
página 292

### SOLID MINERAL

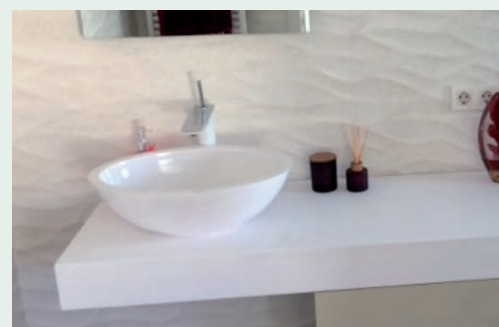

#### Colores

Blanco mate

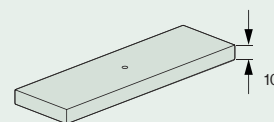
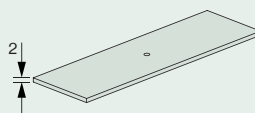

POSICIÓN DEL LAVABO	A (cm)	E(cm)	REF	PVP	REF	PVP
<b>CENTRADO</b>						
	61	30	PS.061.CP	-	PS.061.CM	-
	71	35	PS.071.CP	-	PS.071.CM	-
	81	40	PS.081.CP	-	PS.081.CM	-
	91	45	PS.091.CP	-	PS.091.CM	-
	101	50	PS.101.CP	-	PS.101.CM	-
	121	60	PS.121.CP	-	PS.121.CM	-
	141	70	PS.141.CP	-	PS.141.CM	-
	161	80	PS.161.CP	-	PS.161.CM	-
	181	90	PS.181.CP	-	PS.181.CM	-
	201	100	PS.201.CP	-	PS.201.CM	-
<b>IZQUIERDO</b>						
	91	30	PS.091.IP	-	PS.091.IM	-
	101	35	PS.101.IP	-	PS.101.IM	-
	121	40	PS.121.IP	-	PS.121.IM	-
	141	40	PS.141.IP	-	PS.141.IM	-
	161	40	PS.161.IP	-	PS.161.IM	-
	181	45	PS.181.IP	-	PS.181.IM	-
<b>DERECHO</b>						
	91	30	PS.091.DP	-	PS.091.DM	-
	101	35	PS.101.DP	-	PS.101.DM	-
	121	40	PS.121.DP	-	PS.121.DM	-
	141	40	PS.141.DP	-	PS.141.DM	-
	161	40	PS.161.DP	-	PS.161.DM	-
	181	45	PS.181.DP	-	PS.181.DM	-
<b>DOBLE</b>						
	121	30	PS.121.XP	-	PS.121.XM	-
	141	35	PS.141.XP	-	PS.141.XM	-
	161	40	PS.161.XP	-	PS.161.XM	-
	181	45	PS.181.XP	-	PS.181.XM	-
201	50	PS.201.XP	-	PS.201.XM	-	



#### MEDIDAS ESPECIALES

Es posible pedir sin sobreprecio:

- Anchos especiales. Precio de la medida superior

- Fondo reducido a 40 cm

- Alto de faldón de 5 a 10 cm

#### ORIFICIO DE GRIFO Y LAVABO

Se puede pedir:

- Sin orificio de lavabo y/o grifo

- Eje de lavabo según necesidad

- Mecanizado de lavabo especial fuera de catálogo

#### & complementa

Válvulas y sifones,  
Soportes encimera,  
Toalleros, Zócalos de encimera  
páginas 292-293







SOLID SURFACE 

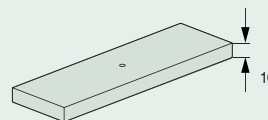
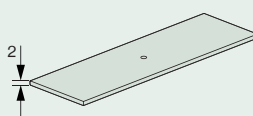

### Colores

 Blanco mate

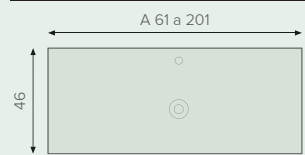
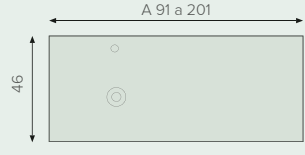
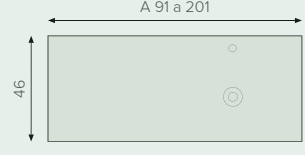

POSICIÓN DEL LAVABO	A (cm)	E(cm)	REF	PVP	REF	PVP	
<b>CENTRADO</b>							 <p><b>MEDIDAS ESPECIALES</b></p> <p>Es posible pedir sin sobreprecio:</p> <ul style="list-style-type: none"> <li>- Anchos especiales. Precio de la medida superior</li> <li>- Fondo reducido a 40 cm</li> <li>- Alto de faldón de 5 a 10 cm</li> </ul> <p><b>ORIFICIO DE GRIFO Y LAVABO</b></p> <p>Se puede pedir:</p> <ul style="list-style-type: none"> <li>- Sin orificio de lavabo y/o grifo</li> <li>- Eje de lavabo según necesidad</li> <li>- Mecanizado de lavabo especial fuera de catálogo</li> </ul>
 <p>A 61 a 201</p>	<b>61</b>	30	PJ.061.CP	-	PJ.061.CM	-	
	<b>71</b>	35	PJ.071.CP	-	PJ.071.CM	-	
	<b>81</b>	40	PJ.081.CP	-	PJ.081.CM	-	
	<b>91</b>	45	PJ.091.CP	-	PJ.091.CM	-	
	<b>101</b>	50	PJ.101.CP	-	PJ.101.CM	-	
	<b>121</b>	60	PJ.121.CP	-	PJ.121.CM	-	
	<b>141</b>	70	PJ.141.CP	-	PJ.141.CM	-	
	<b>161</b>	80	PJ.161.CP	-	PJ.161.CM	-	
<b>181</b>	90	PJ.181.CP	-	PJ.181.CM	-		
<b>201</b>	100	PJ.201.CP	-	PJ.201.CM	-		
<b>IZQUIERDO</b>							
 <p>A 91 a 201</p>	<b>91</b>	30	PJ.091.IP	-	PJ.091.IM	-	
	<b>101</b>	35	PJ.101.IP	-	PJ.101.IM	-	
	<b>121</b>	40	PJ.121.IP	-	PJ.121.IM	-	
	<b>141</b>	40	PJ.141.IP	-	PJ.141.IM	-	
	<b>161</b>	40	PJ.161.IP	-	PJ.161.IM	-	
	<b>181</b>	45	PJ.181.IP	-	PJ.181.IM	-	
<b>DERECHO</b>							
 <p>A 91 a 201</p>	<b>91</b>	30	PJ.091.DP	-	PJ.091.DM	-	
	<b>101</b>	35	PJ.101.DP	-	PJ.101.DM	-	
	<b>121</b>	40	PJ.121.DP	-	PJ.121.DM	-	
	<b>141</b>	40	PJ.141.DP	-	PJ.141.DM	-	
	<b>161</b>	40	PJ.161.DP	-	PJ.161.DM	-	
	<b>181</b>	45	PJ.181.DP	-	PJ.181.DM	-	
<b>DOBLE</b>							
 <p>A 121 a 201</p>	<b>121</b>	30	PJ.121.XP	-	PJ.121.XM	-	
	<b>141</b>	40	PJ.141.XP	-	PJ.141.XM	-	
	<b>161</b>	40	PJ.161.XP	-	PJ.161.XM	-	
	<b>181</b>	45	PJ.181.XP	-	PJ.181.XM	-	
	<b>201</b>	50	PJ.201.XP	-	PJ.201.XM	-	

### & complementa

Válvulas y sifones,  
Soportes encimera,  
Toalleros, Zócalos  
páginas 292-293

### CERAMCOLOR

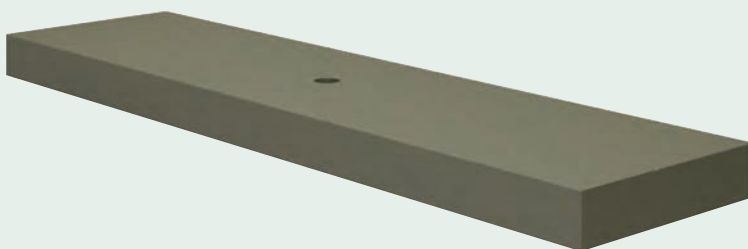
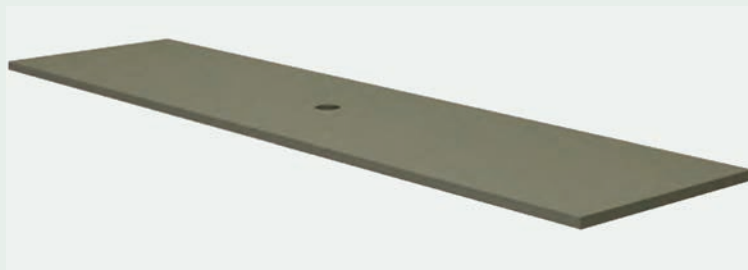

Colores Mate

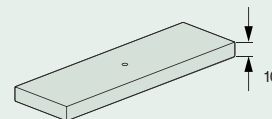
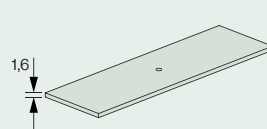

POSICIÓN DEL LAVABO	A (cm)	E(cm)	REF	PVP	REF	PVP
<b>CENTRADO</b>						
	A 61 a 201					
	61	30	PC.061.CP	-	PC.061.CM	-
	71	35	PC.071.CP	-	PC.071.CM	-
	81	40	PC.081.CP	-	PC.081.CM	-
	91	45	PC.091.CP	-	PC.091.CM	-
	101	50	PC.101.CP	-	PC.101.CM	-
	121	60	PC.121.CP	-	PC.121.CM	-
	141	70	PC.141.CP	-	PC.141.CM	-
	161	80	PC.161.CP	-	PC.161.CM	-
181	90	PC.181.CP	-	PC.181.CM	-	
201	100	PC.201.CP	-	PC.201.CM	-	
<b>IZQUIERDO</b>						
	A 91 a 201					
	91	30	PC.091.IP	-	PC.091.IM	-
	101	35	PC.101.IP	-	PC.101.IM	-
	121	40	PC.121.IP	-	PC.121.IM	-
	141	40	PC.141.IP	-	PC.141.IM	-
	161	40	PC.161.IP	-	PC.161.IM	-
	181	45	PC.181.IP	-	PC.181.IM	-
201	50	PC.201.IP	-	PC.201.IM	-	
<b>DERECHO</b>						
	A 91 a 201					
	91	30	PC.091.DP	-	PC.091.DM	-
	101	35	PC.101.DP	-	PC.101.DM	-
	121	40	PC.121.DP	-	PC.121.DM	-
	141	40	PC.141.DP	-	PC.141.DM	-
	161	40	PC.161.DP	-	PC.161.DM	-
	181	45	PC.181.DP	-	PC.181.DM	-
201	50	PC.201.DP	-	PC.201.DM	-	
<b>DOBLE</b>						
	A 121 a 201					
	121	30	PC.121.XP	-	PC.121.XM	-
	141	35	PC.141.XP	-	PC.141.XM	-
	161	40	PC.161.XP	-	PC.161.XM	-
	181	45	PC.181.XP	-	PC.181.XM	-
201	50	PC.201.XP	-	PC.201.XM	-	



#### MEDIDAS ESPECIALES

Es posible pedir sin sobreprecio:

- Anchos especiales. Precio de la medida superior

- Fondo reducido a 40 cm

- Alto de faldón de 5 a 10 cm

#### ORIFICIO DE GRIFO Y LAVABO

Se puede pedir:

- Sin orificio de lavabo y/o grifo

- Eje de lavabo según necesidad

- Mecanizado de lavabo especial fuera de catálogo

#### & complementa

Válvulas y sifones, Soportes encimera, página 292

### PIEDRA NATURAL

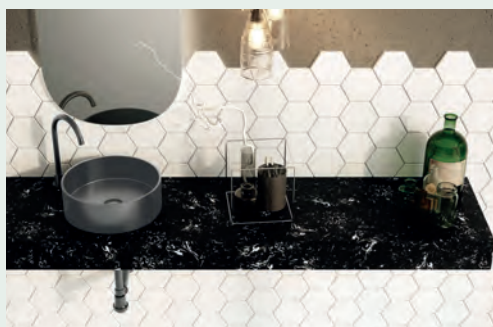

#### Colores

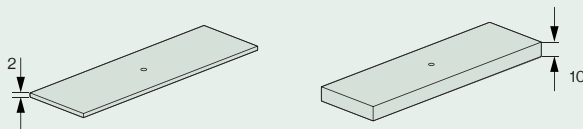
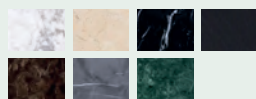

POSICIÓN DEL LAVABO	A (cm)	E(cm)	REF	PVP	REF	PVP
<b>CENTRADO</b>						
	61	30	PQ.061.CP	-	PQ.061.CM	-
	71	35	PQ.071.CP	-	PQ.071.CM	-
	81	40	PQ.081.CP	-	PQ.081.CM	-
	91	45	PQ.091.CP	-	PQ.091.CM	-
	101	50	PQ.101.CP	-	PQ.101.CM	-
	121	60	PQ.121.CP	-	PQ.121.CM	-
	141	70	PQ.141.CP	-	PQ.141.CM	-
	161	80	PQ.161.CP	-	PQ.161.CM	-
	181	90			PQ.181.CM	-
	201	100			PQ.201.CM	-
<b>IZQUIERDO</b>						
	91	30	PQ.091.IP	-	PQ.091.IM	-
	101	35	PQ.101.IP	-	PQ.101.IM	-
	121	40	PQ.121.IP	-	PQ.121.IM	-
	141	40	PQ.141.IP	-	PQ.141.IM	-
	161	40	PQ.161.IP	-	PQ.161.IM	-
	181	45			PQ.181.IM	-
<b>DERECHO</b>						
	91	30	PQ.091.DP	-	PQ.091.DM	-
	101	35	PQ.101.DP	-	PQ.101.DM	-
	121	40	PQ.121.DP	-	PQ.121.DM	-
	141	40	PQ.141.DP	-	PQ.141.DM	-
	161	40	PQ.161.DP	-	PQ.161.DM	-
	181	45			PQ.181.DM	-
<b>DOBLE</b>						
	121	30	PQ.121.XP	-	PQ.121.XM	-
	141	40	PQ.141.XP	-	PQ.141.XM	-
	161	40	PQ.161.XP	-	PQ.161.XM	-
	181	45	PQ.181.XP	-	PQ.181.XM	-
	201	50			PQ.201.XM	-



#### MEDIDAS ESPECIALES

Es posible pedir sin sobreprecio:

- Anchos especiales. Precio de la medida superior

- Fondo reducido a 40 cm

- Alto de faldón de 5 a 10 cm

#### ORIFICIO DE GRIFO Y LAVABO

Se puede pedir:

- Sin orificio de lavabo y/o grifo

- Eje de lavabo según necesidad

- Mecanizado de lavabo especial fuera de catálogo

#### & complementa

Válvulas y sifones, soportes encimera mural, toalleros, zocalos de encimera páginas 292-293

### SOPORTES MURALES

#### SOPORTES FIJACIÓN PARA ENCIMERAS MURALES



REF	PVP
-----	-----

CE01	-
------	---

Colores



### VÁLVULAS

#### VÁLVULAS BASIC



COLOR	REF	PVP
-------	-----	-----

Cromo brillo	CE02	-
Blanco mate	CE03	-
Negro mate	CE04	-

No compatible con Sistema Decospace

Colores



#### VÁLVULAS CERAMCOLOR



COLOR	REF	PVP
-------	-----	-----

Blanco Mate	CE05	-
Negro Mate	CE06	-
Antracita Mate	CE07	-
Tierra Mate	CE08	-

No compatible con Sistema Decospace

Colores



#### VÁLVULAS SOLID



MATERIAL	REF	PVP
----------	-----	-----

Solid Mineral	CE09	-
Solid Surface	CE10	-

No compatible con Sistema Decospace

Colores



#### EMBELLECEDOR PARA VÁLVULA DECOSPACE



COLOR	REF	PVP
-------	-----	-----

Blanco mate	CE11	-
Negro mate	CE12	-
Oro brillo	CE13	-

Colores



SIFÓN DECORATIVO

SIFÓN DECORATIVO



COLOR	REF	PVP
Cromo brillo	CE14	-
Blanco mate	CE15	-
Negro mate	CE16	-

Colores



TOALLEROS

TOALLERO FRONTAL (INTEGRADO)



MATERIAL	REF	PVP
Piedra Natural	CE17	-
Solid Mineral	CE18	-
Solid Surface	CE19	-

Colores Piedra

Colores

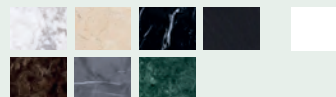

TOALLERO LATERAL ENCIMERA

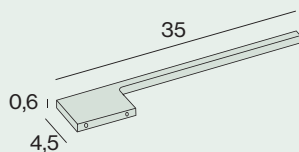

COLOR	REF	PVP
Cromo brillo	CM8.CB	-
Negro mate	CM8.BK	-
Color (carta laca)	CM8.CO	-

Colores



Colores Laca



ZÓCALOS DE ENCIMERA



A(cm)	SOLID MINERAL		SOLID SURFACE		PIEDRA NATURAL	
	REF	PVP (metro linea)	REF	PVP (metro linea)	REF	PVP (metro linea)
De 40 a 100	CE20	-	CE23	-	CE26	-
De 100 a 160	CE21	-	CE24	-	CE27	-
De 160 a 200	CE22	-	CE25	-	CE28	-

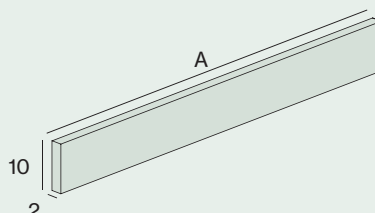

Colores Piedra

Colores

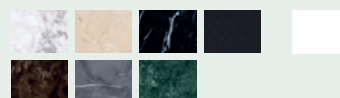





# 04 Espejos

La fusión del espejo con la mejor tecnología LED se une a espejos lisos, biselados y enmarcados con diferentes formatos para dar solución a cada proyecto.

**LISOS**

Amplia gama de espejos esenciales con cantos pulidos.

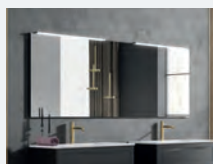

**Rectangular Liso**

pág. 300

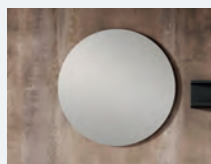

**Round Liso**

pág. 300

**RETROILUMINACIÓN TRASERA**

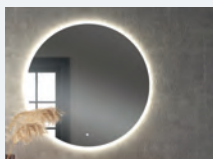

**Rounded**

pág. 301

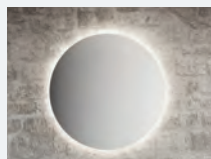

**Circled**

pág. 301



**Retroled**

pág. 302

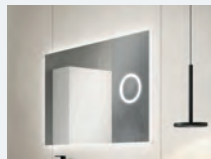

**Filed**

pág. 302



**Spinled**

pág. 303



**Frameled**

pág. 303

**RETROILUMINACIÓN FRONTAL**

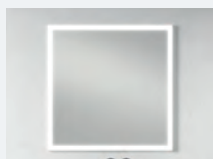

**Fronled**

pág. 304



**Duoled**

pág. 304



**Triled**

pág. 305



**Eyeled**

pág. 305



**ENMARCADOS METAL**



**Metalroundled**

pág. 306



**Metalsquareled**

pág. 306



**Metalround**

pág. 307



**Metalsquare**

pág. 307

**ENMARCADOS MADERA**

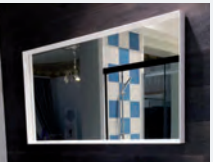

**Corner**

pág. 308



**Luxor**

pág. 308

**ARMARIOS ESPEJO**

Armario de puertas con gran capacidad y funcionalidad totalmente revestidos de espejo.



**Armario Espejo 1 puerta**

pág. 309



**Armario Espejo 2 puertas**

pág. 309

**COMPLEMENTA TU ESPEJO**

Personaliza tu espejo con opcionales como antivaho, sensores, luces, etc.

pág. 310

Cada una de las soluciones se puede personalizar a medida.

Nuestros productos están certificados y cumplen el certificado CE y con IP44 en el caso de espejos retroiluminados.

Todos los espejos tienen un espesor de 4 mm con cantos pulidos y se suministran con los herrajes necesarios para su colocación con colgadores regulables.

Los espejos lisos llevan terminaciones laterales acabadas en cromo brillo y una espuma antishock que permite un perfecto ajuste con la pared y evita las vibraciones del espejo.

Los espejos lisos pueden llevar el sistema SAFE SYSTEM por el que se ofrece una seguridad extra que evita que ante una rotura se pueda desprender un trozo.

Espejos con iluminación led.  
Ver info técnica de iluminación pág. 317.

## Descubre las diferentes opciones que te ofrecen la mayoría de los espejos



### ESPEJOS CON ANTIVAHÓ

Puedes equipar el espejo con sistema antivaho. Una lámina térmica adherida a la parte trasera del espejo evitará la condensación del agua sobre el espejo mejorando el confort de uso y la perfecta reflexión del espejo.



### ESPEJOS CON LUZ FRÍA Y/O CÁLIDA

Puedes personalizar tu espejo con la temperatura de color que desees, más cálida o más fría, de 3000°k a 5500°K. Incluso puedes equipar tu espejo con un sensor táctil que te permitirá el cambio de temperatura de color, ya sea, cálida, neutra o fría.



### ESPEJOS CON SENSOR ENCENDIDO ON/OFF

Esta opción te permitirá encender/apagar el espejo y cambiar la intensidad lumínica si así lo necesitas con una ligera presión sobre el sensor táctil.



### SISTEMA SCREEN CON SENSOR ENCENDIDO ON/OFF

La tecnología nos permite replicar la pantalla de tu móvil en el espejo. Con ello, podrás reproducir en el espejo de una manera fácil todos los contenidos de tu móvil como videos y fotos. Compatible con IOS y Android.



### ESPEJOS CON BLUETOOTH

Puedes vincular tu móvil al espejo por bluetooth y disfrutar tu música en el baño.



### SENSOR ANTIVAHÓ

Sensor ON/OFF para lámina antivaho.

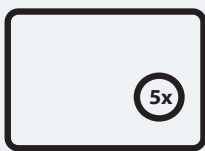

### ESPEJO AUMENTO X5 LED

Puedes personalizar tu espejo con un espejo de aumento x5 con LED integrado.

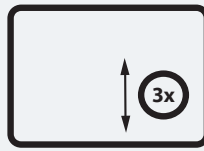

### ESPEJO AUMENTO MÓVIL

Puedes equipar el espejo con un espejo x3 imantado que te permite colocarlo en la zona derecha del espejo y regular su posición de altura o guardarlo en el mueble.

**RECTANGULAR LISO: Estándar y a medida**

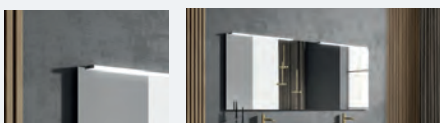

- Estándar básico: con placa de colgar.
- Estándar securizado: espejo con sistema de seguridad y laterales cromo antishock.
- A medida securizado: espejo a medida con sistema de seguridad y laterales cromo antishock.

TIPOS	A (cm)	H (cm)	REF	PVP
<b>Estándar básico</b>				
60	80	80	SLB.06080	-
70	80	80	SLB.07080	-
80	80	80	SLB.08080	-
90	80	80	SLB.09080	-
100	80	80	SLB.10080	-
120	80	80	SLB.12080	-
140	80	80	SLB.14080	-
<b>Estándar securizado</b>				
60	80	80	SLS.06080	-
70	80	80	SLS.07080	-
80	80	80	SLS.08080	-
90	80	80	SLS.09080	-
100	80	80	SLS.10080	-
120	80	80	SLS.12080	-
140	80	80	SLS.14080	-
<b>A medida securizado</b>				
60 a 80	50 a 90	50 a 90	SLM.08090	-
81 a 100	50 a 90	50 a 90	SLM.10090	-
101 a 120	50 a 90	50 a 90	SLM.12090	-
121 a 140	50 a 90	50 a 90	SLM.14090	-
141 a 160	50 a 90	50 a 90	SLM.16090	-
161 a 180	50 a 90	50 a 90	SLM.18090	-
181 a 200	50 a 90	50 a 90	SLM.20090	-
40 a 60	150 a 200	150 a 200	SLM.040200	-

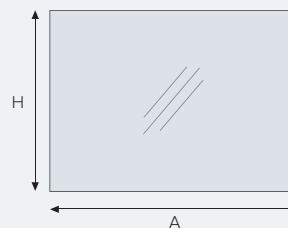

**& complementa**  
 Sistema Antivaho,  
 Sensor Antivaho,  
 Led 5X  
 Pág.....310

**ROUND LISO: Espejo liso redondo estándar**

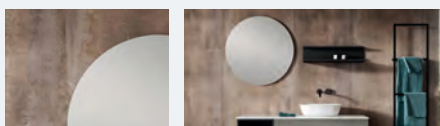

- Espejo con placa de colgar

D (cm)	REF	PVP
60	SR.06060	-
70	SR.07070	-
80	SR.08080	-
90	SR.09090	-
100	SR.100100	-
120	SR.120120	-

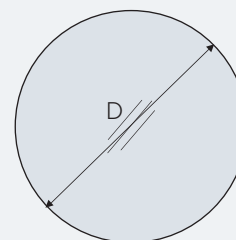

### ROUNDLED: Retroiluminación lateral y bisel perimetral

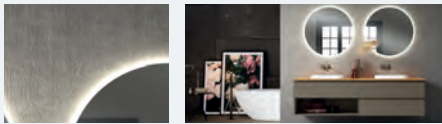

LUZ	COLOR°K	CONSUMO	POTENCIA	ESTANQUEIDAD
LED	5500K Blanca	9.6W	960 LUMENS metro lineal	IP44

Personaliza tu LED en 3000°K ó 4200°K sin extra de precio. Standard de 5500°K.

D (cm)	REF	PVP
60	SD.6060	-
80	SD.8080	-

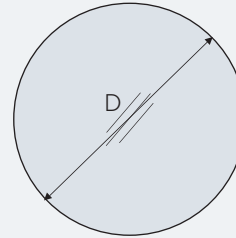

#### & complementa

Sensor On/Off,  
Sensor Antivaho,  
Sistema Antivaho  
Pág....310

### CIRCLED: Retroiluminación Perimetral

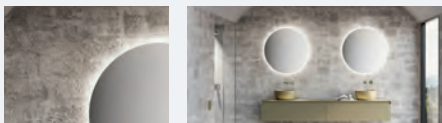

LUZ	COLOR°K	CONSUMO	POTENCIA	ESTANQUEIDAD
LED	5500K Blanca	9.6W	960 LUMENS metro lineal	IP44

Personaliza tu LED en 3000°K ó 4200°K sin extra de precio. Standard de 5500°K.

D (cm)	REF	PVP
60	SC.06060	-
70	SC.07070	-
80	SC.08080	-
90	SC.09090	-
100	SC.100100	-

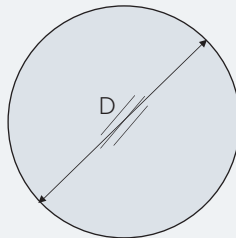

#### & complementa

Sensor On/Off,  
Sensor Antivaho,  
Sistema Antivaho  
Pág.....310

### RETROLED: Retroiluminación superior e inferior

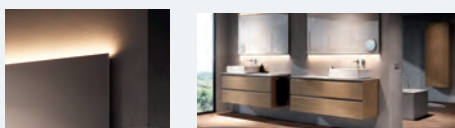

· Estándar y a medida

LUZ	COLOR*°K	CONSUMO	POTENCIA	ESTANQUEIDAD
LED	5500K Blanca	9.6W	960 LUMENS metro lineal	IP44

Personaliza tu LED en 3000°K ó 4200°K sin extra de precio. Standard de 5500°K.

TIPOS	A (cm)	H (cm)	REF	PVP
<b>Estándar</b>				
	60	80	ST.06080	-
	80	80	ST.08080	-
	100	80	ST.10080	-
	120	80	ST.12080	-
	140	80	ST.14080	-
<b>A medida</b>				
	60 a 80	50 a 72	ST.08072	-
	81 a 100	50 a 72	ST.10072	-
	101 a 120	50 a 72	ST.12072	-
	121 a 140	50 a 72	ST.14072	-
	141 a 160	50 a 72	ST.16072	-
	161 a 180	50 a 72	ST.18072	-
	181 a 200	50 a 72	ST.20072	-
	60 a 80	73 a 90	ST.08090	-
	81 a 100	73 a 90	ST.10090	-
	101 a 120	73 a 90	ST.12090	-
	121 a 140	73 a 90	ST.14090	-
	141 a 160	73 a 90	ST.16090	-
	161 a 180	73 a 90	ST.18090	-
	181 a 200	73 a 90	ST.20090	-

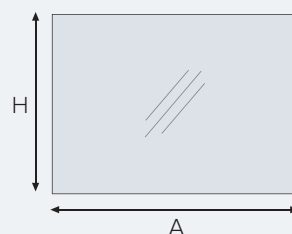

#### & complementa

Sistema Antivaho,  
Led 5X,  
Sensor On/Off,  
Sensor Colour,  
Sistema Bluetooth,  
Sistema Screen,  
Págs.....310-312

### FILED : Retroiluminación y Bisel Perimetral

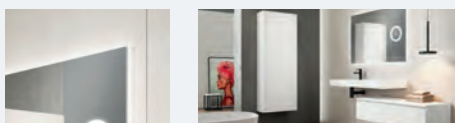
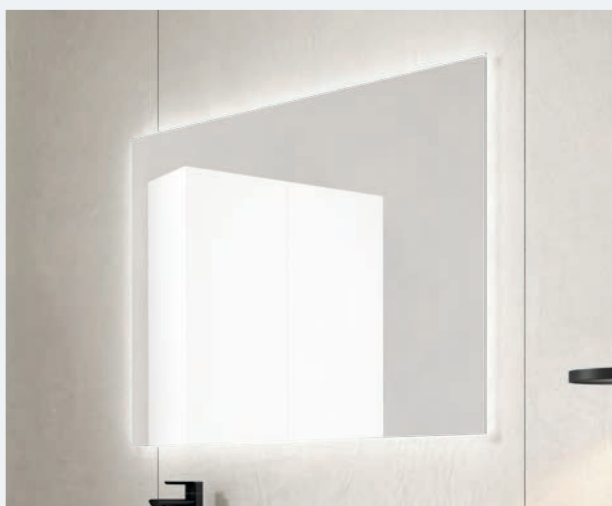

LUZ	COLOR*°K	CONSUMO	POTENCIA	ESTANQUEIDAD
LED	5500K Blanca	9.6W	960 LUMENS metro lineal	IP44

Personaliza tu LED en 3000°K ó 4200°K sin extra de precio. Standard de 5500°K.

TIPOS	A (cm)	H (cm)	REF	PVP
<b>Estándar</b>				
	60	80	SF.06080	-
	80	80	SF.08080	-
	100	80	SF.10080	-
	120	80	SF.12080	-
	140	80	SF.14080	-
<b>A medida</b>				
	60 a 80	50 a 72	SF.08072	-
	81 a 100	50 a 72	SF.10072	-
	101 a 120	50 a 72	SF.12072	-
	121 a 140	50 a 72	SF.14072	-
	141 a 160	50 a 72	SF.16072	-
	161 a 180	50 a 72	SF.18072	-
	181 a 200	50 a 72	SF.20072	-
	60 a 80	73 a 90	SF.08090	-
	81 a 100	73 a 90	SF.10090	-
	101 a 120	73 a 90	SF.12090	-
	121 a 140	73 a 90	SF.14090	-
	141 a 160	73 a 90	SF.16090	-
	161 a 180	73 a 90	SF.18090	-
	181 a 200	73 a 90	SF.20090	-

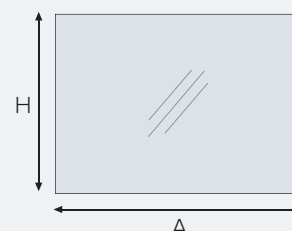

#### & complementa

Sistema Antivaho,  
Led 5X,  
Sensor On/Off,  
Sensor Colour,  
Sistema Bluetooth,  
Sistema Screen,  
Págs.....310-312

### SPINLED: Retroiluminación perimetral

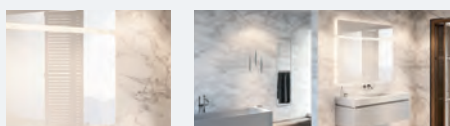

LUZ	COLOR °K	CONSUMO	POTENCIA	ESTANQUEIDAD
LED	5500K Blanca	9.6W	960 LUMENS metro lineal	IP44

Personaliza tu LED en 3000°K ó 4200°K sin extra de precio. Standard de 5500°K.

TIPOS	A (cm)	H (cm)	REF	PVP
Estándar	60	80	SP.06080	-
	80	80	SP.08080	-
	100	80	SP.10080	-
	120	80	SP.12080	-
	140	80	SP.14080	-
A medida	60 a 80	50 a 72	SP.08072	-
	81 a 100	50 a 72	SP.10072	-
	101 a 120	50 a 72	SP.12072	-
	121 a 140	50 a 72	SP.14072	-
	141 a 160	50 a 72	SP.16072	-
	161 a 180	50 a 72	SP.18072	-
	181 a 200	50 a 72	SP.20072	-
	60 a 80	73 a 90	SP.08090	-
	81 a 100	73 a 90	SP.10090	-
	101 a 120	73 a 90	SP.12090	-
	121 a 140	73 a 90	SP.14090	-
	141 a 160	73 a 90	SP.16090	-
	161 a 180	73 a 90	SP.18090	-
181 a 200	73 a 90	SP.20090	-	

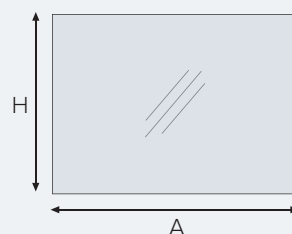

#### & complementa

Sistema Antivaho,  
Led 5X,  
Sensor On/Off,  
Sensor Colour,  
Sistema Bluetooth,  
Sistema Screen,  
Págs.....310-312

### FRAMELED: Retroiluminación Perimetral y Led Frontal

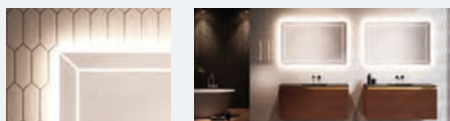

· El sensor apaga y enciende la luz Led perimetral y frontal

LUZ	COLOR °K	CONSUMO	POTENCIA	ESTANQUEIDAD
LED	5500K Blanca	9.6W	960 LUMENS metro lineal	IP44

A (cm)	H (cm)	REF	PVP
60	80	SM.06080	-
80	80	SM.08080	-

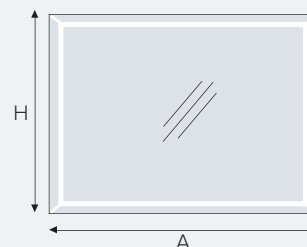

### FRONLED: Iluminación frontal 4 perimetral

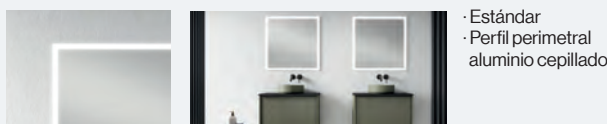
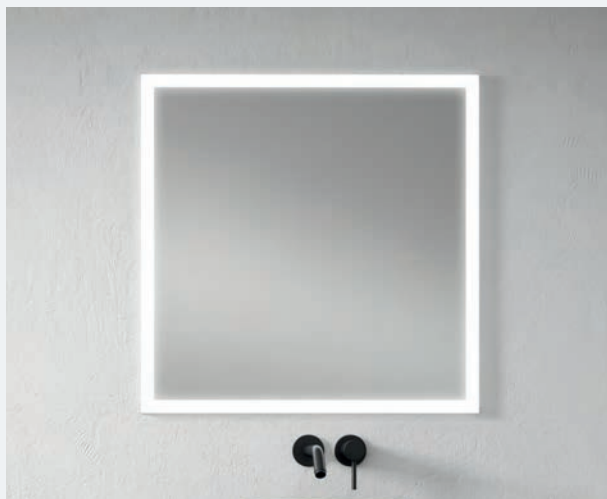

- Estándar
- Perfil perimetral aluminio cepillado

LUZ	COLOR °K	CONSUMO	POTENCIA	ESTANQUEIDAD
LED	5500°K Blanca	9.6W	960 LUMENS metro lineal	IP44

Personaliza tu LED en 3000°K ó 4200°K sin extra de precio. Standard de 5500°K.

A (cm)	H (cm)	REF	PVP
60	80	SA.06080	-
80	80	SA.08080	-
100	80	SA.10080	-
120	80	SA.12080	-

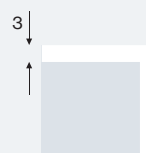
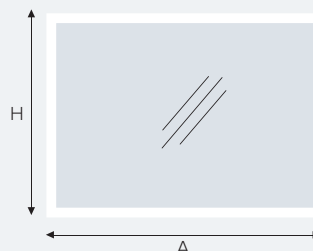

#### & complementa

Sistema Antivaho,  
Led 5X,  
Sensor On/Off,  
Sensor Colour,  
Sistema Bluetooth,  
Sistema Screen,  
Págs.....310-312

### DUOLED: Iluminación frontal lateral

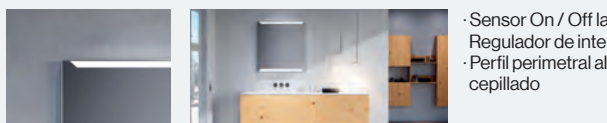
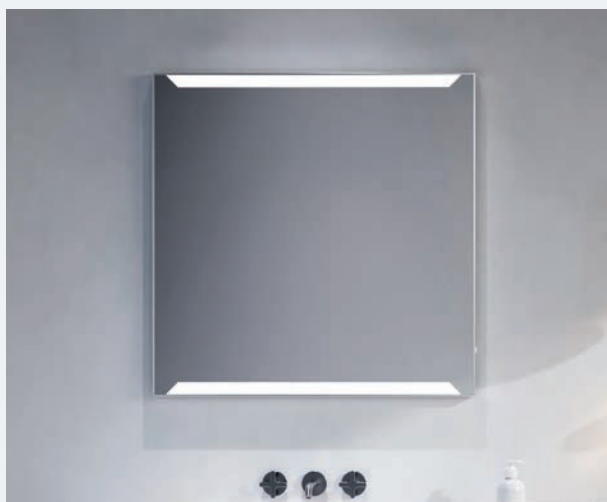

- Sensor On / Off lateral + Regulador de intensidad
- Perfil perimetral aluminio cepillado

LUZ	COLOR °K	CONSUMO	POTENCIA	ESTANQUEIDAD
LED	5500°K Blanca	9.6W	960 LUMENS metro lineal	IP44

Personaliza tu LED en 3000°K ó 4200°K sin extra de precio. Standard de 5500°K.

A (cm)	H (cm)	REF	PVP
60	80	SG.06080	-
80	80	SG.08080	-
100	80	SG.10080	-
120	80	SG.12080	-

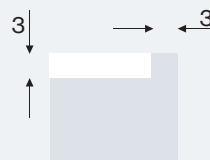
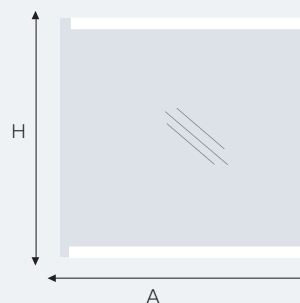

#### & complementa

Sistema Antivaho,  
Led 5X,  
Págs.....310



### TRILED: Iluminación frontal superior y lateral

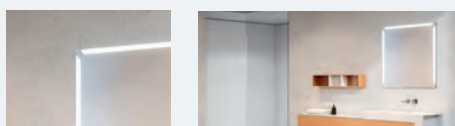

Perfil perimetral aluminio cepillado

LUZ	COLOR °K	CONSUMO	POTENCIA	ESTANQUEIDAD
LED	5500K Blanca	9.6W	960 LUMENS metro lineal	IP44

Personaliza tu LED en 3000°K ó 4200°K sin extra de precio. Standard de 5500°K.

A (cm)	H (cm)	REF	PVP
60	80	SH.06080	-
80	80	SH.08080	-
100	80	SH.10080	-
120	80	SH.12080	-

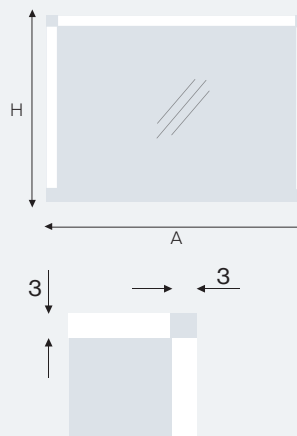

#### & complementa

Sistema Antivaho,  
Led 5X,  
Sensor On/Off,  
Sensor Colour,  
Sistema Bluetooth,  
Sistema Screen,  
Págs.....310-312

### EYELED: Iluminación frontal

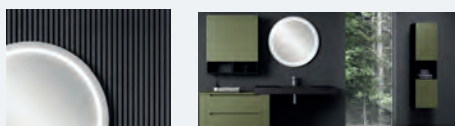

LUZ	COLOR °K	CONSUMO	POTENCIA	ESTANQUEIDAD
LED	5500K Blanca	9.6W	960 LUMENS metro lineal	IP44

Personaliza tu LED en 3000°K ó 4200°K sin extra de precio. Standard de 5500°K.

D (cm)	REF	PVP
60	SY.06060	-
80	SY.08080	-

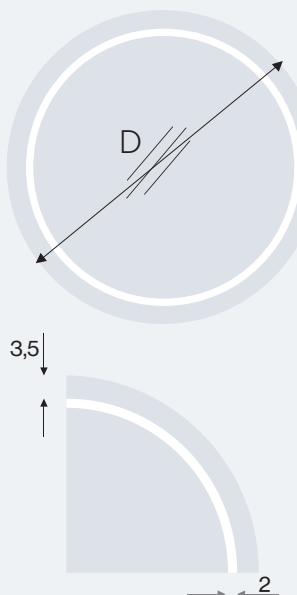

#### & complementa

Sistema Antivaho,  
Sensor On/Off,  
Sensor Antivaho  
Págs.....310-312

**METALROUNDLED: Liso + Led metal redondo**

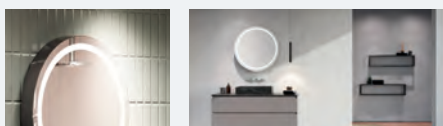

COLORES:  
 Negro  
 Cromo

LUZ	COLOR °K	CONSUMO	POTENCIA	ESTANQUEIDAD
LED	5500K Blanca	9.6W	960 LUMENS metro lineal	IP44

Personaliza tu LED en 3000°K y 4200°K sin extra de precio. Standard de 5500°K.

TIPOS	D (cm)	REF	PVP
-------	--------	-----	-----

Negro	60	SJ.06060.N	-
	80	SJ.08080.N	-

Cromo	60	SJ.06060.CR	-
	80	SJ.08080.CR	-

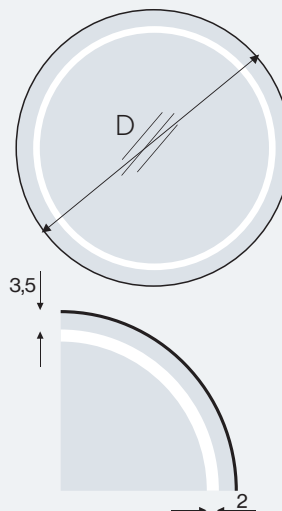

**& complementa**

Sistema Antivaho,  
 Sensor On/Off,  
 Sensor Antivaho  
 Págs.....310-312

**METALSQUARELED: Liso + Led metal cuadrado**

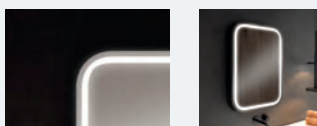

COLORES:  
 Negro  
 Cromo

LUZ	COLOR °K	CONSUMO	POTENCIA	ESTANQUEIDAD
LED	5500K Blanca	9.6W	960 LUMENS metro lineal	IP44

Personaliza tu LED en 3000°K y 4200°K sin extra de precio. Standard de 5500°K.

TIPOS	A (cm)	H (cm)	REF	PVP
-------	--------	--------	-----	-----

Negro	60	80	SK.06080.N	-
	80	80	SK.08080.N	-
	100	80	SK.10080.N	-
	120	80	SK.12080.N	-

Cromo	60	80	SK.06080.CR	-
	80	80	SK.08080.CR	-
	100	80	SK.10080.CR	-
	120	80	SK.12080.CR	-

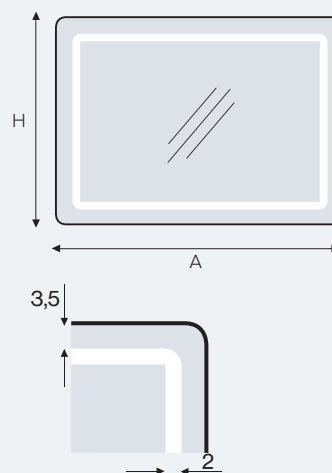

**& complementa**

Sistema Antivaho,  
 Sensor On/Off,  
 Sensor Antivaho  
 Págs.....310-312

**METALROUND:** Liso metal redondo



COLORES:  
 Negro  
 Cromo

TIPOS	D (cm)	REF	PVP
Negro	60	SL.06060.N	-
	80	SL.08080.N	-
Cromo	60	SL.06060.CR	-
	80	SL.08080.CR	-

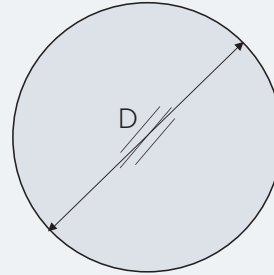

**& complementa**

Sistema Antivaho  
 Págs.....310

**METALSQUARE:** Liso metal cuadrado



COLORES:  
 Negro  
 Cromo

TIPOS	A (cm)	H (cm)	REF	PVP
Negro	60	80	SQ.06080.N	-
	80	80	SQ.08080.N	-
	100	80	SQ.10080.N	-
	120	80	SQ.12080.N	-
Cromo	60	80	SQ.06080.CR	-
	80	80	SQ.08080.CR	-
	100	80	SQ.10080.CR	-
	120	80	SQ.12080.CR	-

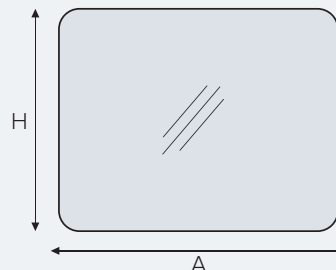

**& complementa**

Sistema Antivaho,  
 Led 5X  
 Págs.....310

## CORNER: Enmarcado Madera con Perfil Prismático

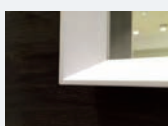

### COLORES

- Blanco mate
- Negro mate

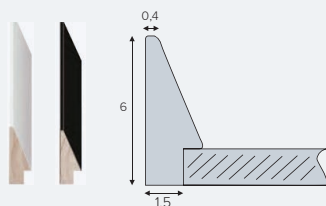

A (cm)	H (cm)	REF	PVP
60 a 80	60 a 90	SU.08090	-
81 a 100	60 a 90	SU.10090	-
101 a 120	60 a 90	SU.12090	-
121 a 140	60 a 90	SU.14090	-
141 a 160	60 a 90	SU.16090	-
161 a 180	60 a 90	SU.18090	-
181 a 200	60 a 90	SU.20090	-
40 a 60	150 a 200	SU.060200	-

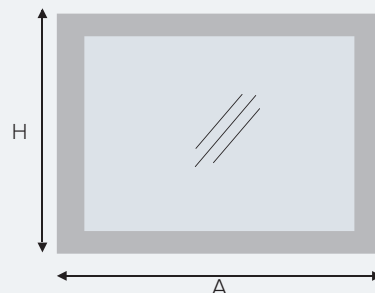

## LUXOR: Enmarcado Madera Decorativo



### COLORES

- Pan de plata
- Pan de oro

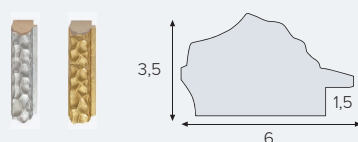

A (cm)	H (cm)	REF	PVP
60 a 80	60 a 90	SX.08090	-
81 a 100	60 a 90	SX.10090	-
101 a 120	60 a 90	SX.12090	-
121 a 140	60 a 90	SX.14090	-
141 a 160	60 a 90	SX.16090	-
161 a 180	60 a 90	SX.18090	-
181 a 200	60 a 90	SX.20090	-
40 a 60	150 a 200	SX.060200	-

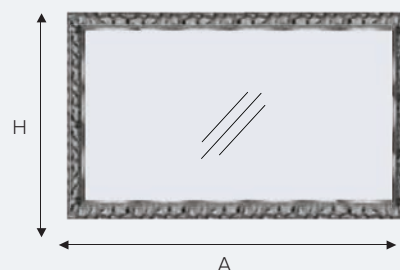

### ARMARIO ESPEJO 1 PUERTA

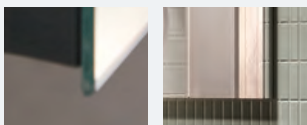
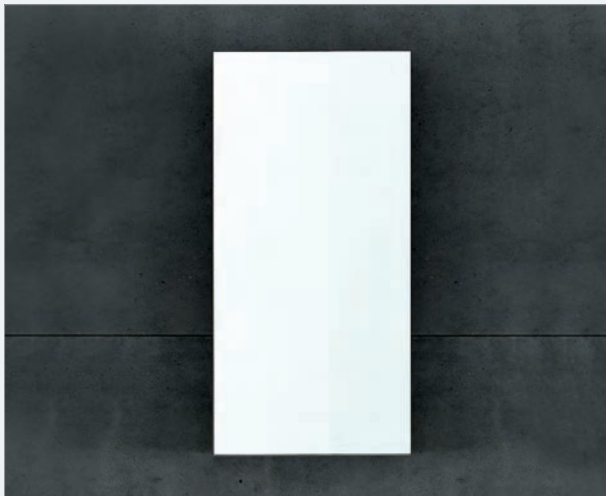

- Colgadores regulables
- Modulable
- Laterales espejo
- 2 Estantes interiores de cristal
- Interior color antracita
- Compatible con apliques para espejo
- Puerta con tirador inferior oculto y cierre amortiguado

A (cm)	H (cm)	Apertura	REF	PVP
30	72		SW.3072I	-
30	72		SW.3072D	-
40	72		SW.4072I	-
40	72		SW.4072D	-
60	72		SW.6072I	-
60	72		SW.6072D	-

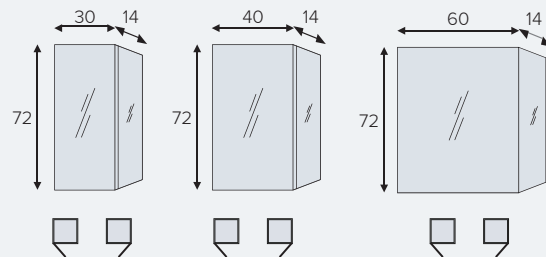
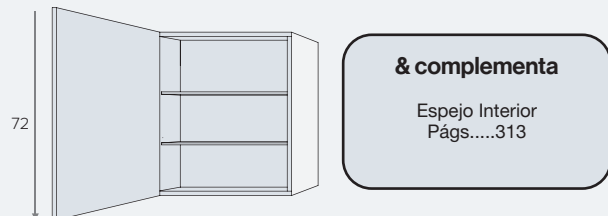

### ARMARIO ESPEJO 2 PUERTAS

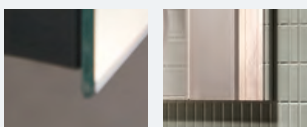

- Colgadores regulables
- Modulable
- Laterales espejo
- 2 Estantes interiores de cristal
- Interior color antracita
- Compatible con apliques para espejo
- Puerta con tirador inferior oculto y cierre amortiguado

A (cm)	H (cm)	Apertura	REF	PVP
80 (60+20)	72		SZ.8072I	-
80 (20+60)	72		SZ.8072D	-
90 (60+30)	72		SZ.9072I	-
90 (30+60)	72		SZ.9072D	-
100 (60+40)	72		SZ.10072I	-
100 (40+60)	72		SZ.10072D	-

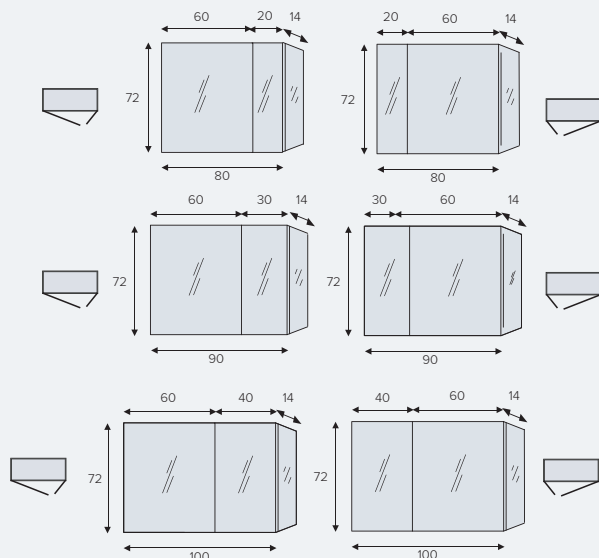
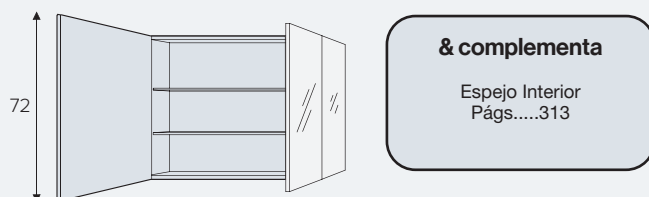

**SISTEMA ANTIVAHO**

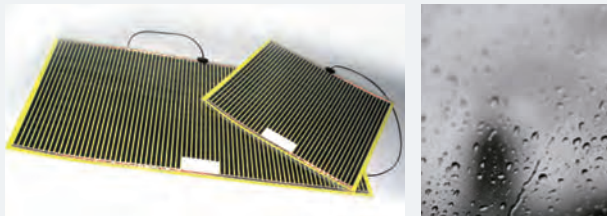

CONSUMO	ESTANQUEIDAD
9.6W	IP44

**SENSOR ANTIVAHO**



Antivaho



**LED 5X**



LED 5X



Ø 17cm

REF		PVP
-----	--	-----

X004UNO	(Indicado para muebles de un lavabo)	-
---------	--------------------------------------	---

X004DOS	(Indicado para muebles de dos lavabos)	-
---------	--	---

**Sistema Antivaho**

Evita la condensación del agua sobre el espejo que distorsiona la imagen. Puede ir conectado directamente a la red eléctrica o bien encenderlo y apagarlo con el sensor táctil.

En función del equipamiento y estructura del espejo, nuestro departamento industrial escogerá el sistema antivaho más adecuado a la medida del espejo.

REF	PVP
-----	-----

X008	-
------	---

Requiere de Sistema Antivaho

**Sensor Antivaho**

Permite encender y apagar el sistema antivaho.

REF	PVP
-----	-----

X015	-
------	---

**LED 5X**

Espejo de aumento 5X integrado en el propio espejo. Perímetro iluminado mediante luz Led.

**SENSOR ON / OFF**



On / Off  
+  
Regulador de  
intensidad

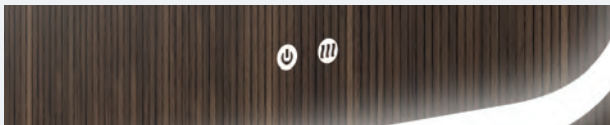

**SENSOR COLOUR**

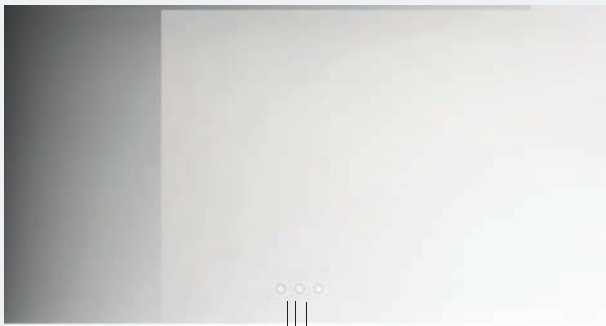

On / Off — 3000°K  
5000°K  
Regulador de  
Intensidad



**TIPO**

**REF**

**PVP**

Sensor ON/OFF Sin Sensor Antivaho	X007	-
Sensor ON/OFF Con Sensor Antivaho (requiere X004DOS o X008)	X009	-

**SENSOR ON / OFF**

Encender o apagar la luz Led y también permite regular la intensidad de esta a la elección del usuario.

**& compatible** con Sistema Antivaho y Led 5X

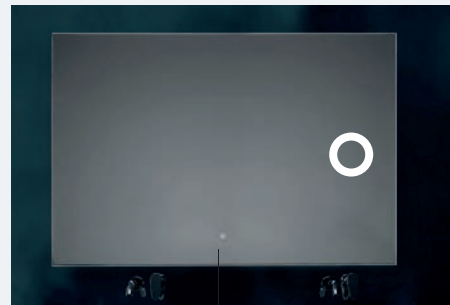

Antivaho  
(Opcional)

LED 5X  
(Opcional)

**REF**

**PVP**

X011

-

**SENSOR COLOUR**

Permite cambiar la temperatura de color de luz cálida, neutra o fría y/o la intensidad de la luz.

**& compatible** con Sistema Antivaho y Led 5X

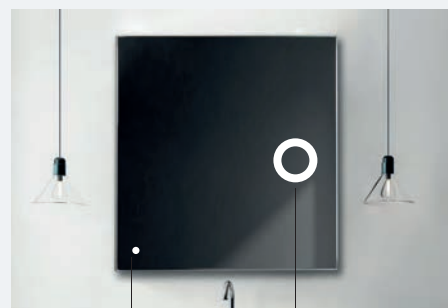

Antivaho  
(Opcional)

LED 5X  
(Opcional)

**SISTEMA BLUETOOTH**

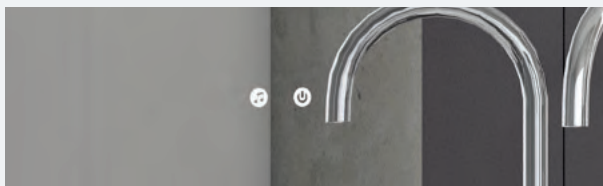
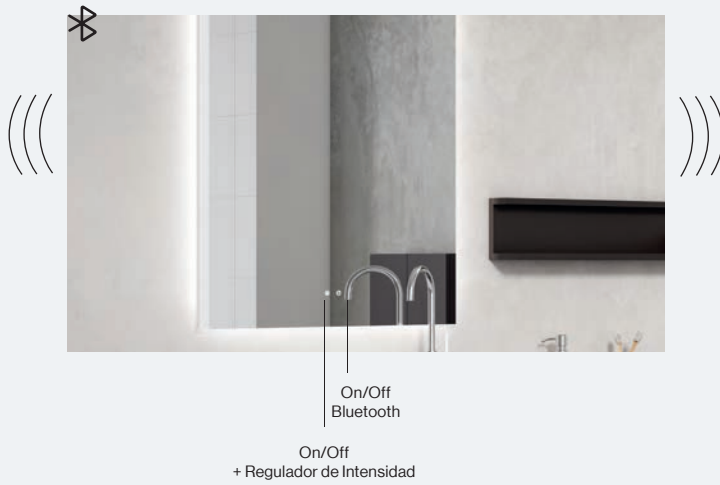

REF

PVP

X013

**SISTEMA BLUETOOTH**

Permite vincular el espejo al teléfono móvil a través del dispositivo Bluetooth. También incluye un sistema de altavoces incorporado en el espejo. Incluye el sistema On/Off de encendido y regulación de intensidad.

**& compatible** con Sistema Antivaho y Led 5X



Antivaho (Opcional)

LED 5X (Opcional)

**SISTEMA SCREEN**

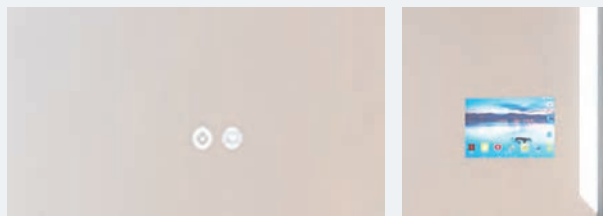
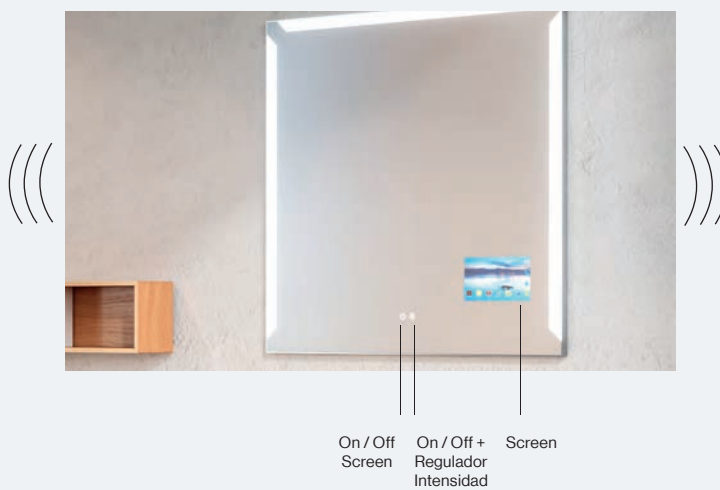

Tamaño Screen:  
17 ancho x 10 alto (cm)

REF

PVP

X012

Disponible a partir de espejos de 80 cm de ancho.

**SISTEMA SCREEN**

Permite vincular el espejo al teléfono móvil a través del dispositivo Bluetooth y replica la pantalla del móvil. Pantalla de 10 pulgadas. Incluye el sistema con On/Off de encendido y regulación de intensidad.

**& compatible** con Sistema Antivaho

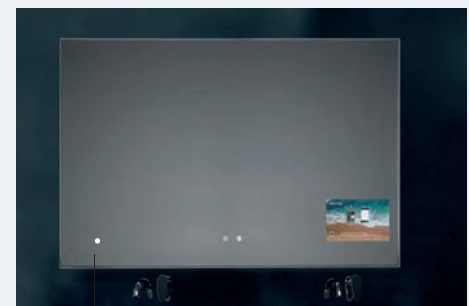

Antivaho (Opcional)



### ESPEJO AUMENTO 3X IMANTADO

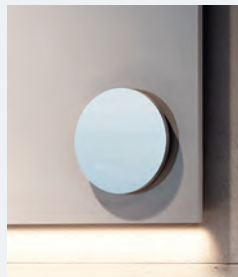

D (cm)	REF	PVP
--------	-----	-----

14	98912 MAG	-
----	-----------	---

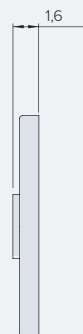
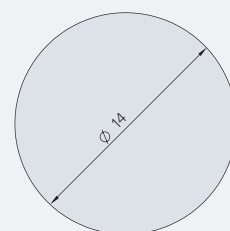

### ESPEJO INTERIOR ARMARIO-ESPEJO



Apto para armarios-espejo y armarios de colgar.

PUERTA	A (cm)	H (cm)	REF	PVP
--------	--------	--------	-----	-----

30/40/60	22	68	98922INT	-
----------	----	----	----------	---

20*	12	68	98923INT	-
-----	----	----	----------	---

\*Para puerta de 20 cm el espejo interior es de 12 cm de ancho.

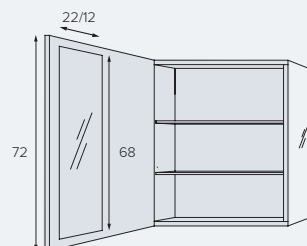



# 05 Iluminación

La tecnología LED aplicada en apliques para espejo y en iluminación decorativa permite crear escenas personalizadas.



**APLIQUES PARA ESPEJOS**

Apliques para instalar en la parte superior de los espejos y espejos armario. Diferentes diseños, potencias y temperaturas de color.



**Ledin**  
pág. 318



**Ledcrl**  
pág. 318

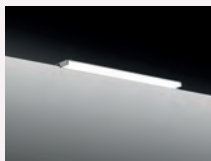

**Ledbar**  
pág. 319

**ILUMINACIÓN DECORATIVA**

Iluminación decorativa colgante y una luz personalizable para crear ambientes.



**Ledarc**  
pág. 320

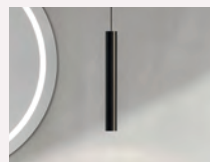

**Ledpoint**  
pág. 320

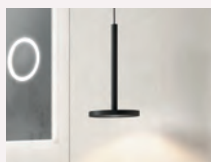

**Ledcirc**  
pág. 321

## ¿Qué debes saber para tener una buena iluminación en tu baño?

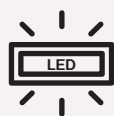

### TIPO DE LUZ

El tipo de luz led es de muy bajo consumo, de encendido rápido y de gran durabilidad; además, no emite calor. Para su funcionamiento necesita un driver que en muchos casos está integrado en el propio aplique.



### CONSUMO

Se mide en watos (w). A menos watos, menor consumo. El "w" no es la referencia para medir la intensidad de luz y su capacidad luminica; sino que para ello, nos fijaremos en los lumens/ luxes.

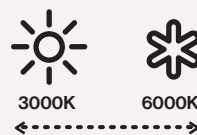

### TEMPERATURA DE COLOR

Es la tonalidad de la luz, expresada en grados kelvin (°K). Un tono cálido que es más amarillento está situado en unos 3000°K y un tono frío que es más blanco está en unos 5000-6000°K. La tendencia es ir hacia tonos neutros que se sitúan en 4000°K.



### LUMENS

La variable para identificar si un aplique da más luz que otro son los lúmenes. A más lúmenes, mayor intensidad de luz.

Según los códigos generales de iluminación en un baño hay dos necesidades de luz.

- La zona del mueble de lavabo. Para maquillarse o afeitarse se recomienda un mínimo de 300 lumens. En torno a 700 lumens es ideal para ayudar a la iluminación general del baño. Si además la iluminación es neutra (4000°K) ayuda a que no se alteren los colores de la piel.
- La zona de paso. Los focos de techo nos tienen que aportar una luz general suave. Se recomienda en torno a 200-300 lúmenes por m<sup>2</sup>.



### ESTANQUEIDAD

Es el nivel de exposición a intemperie o agentes externos como el agua. Se mide por IP, y van desde IP20, IP44 e IP65, de menos a más estanco.

### LEDIN



Compatible con espejos lisos y espejos armario

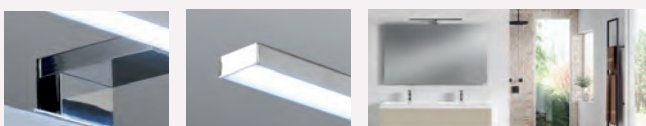

LUZ	COLOR °K	CONSUMO	POTENCIA	ESTANQUEIDAD
LED	4000°K Neutra	4.9W 8W	960 LUMENS metro lineal	IP20

A (cm)	Color	Temp (°K)	Consumo (W)	Lumens (lm)	REF	PVP
30	Cromo brillo	4000	4.9	325	LAI.30.B	-
45	Cromo brillo	4000	8	465	LAI.45.B	-

30	Negro	4000	4.9	325	LAI.30.N	-
45	Negro	4000	8	465	LAI.45.N	-

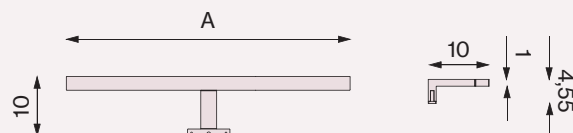

### LED CRIL

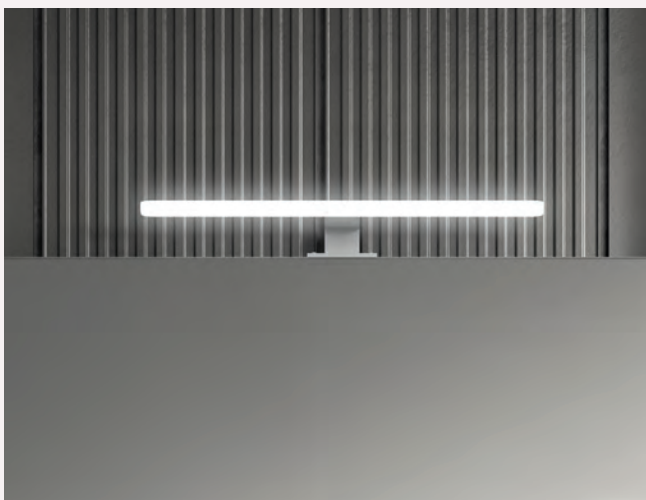

Compatible con espejos lisos y espejos armario



LUZ	COLOR °K	CONSUMO	POTENCIA	ESTANQUEIDAD
LED	4000°K Neutra	8W 12W	960 LUMENS metro lineal	IP20

A (cm)	Color	Temp (°K)	Consumo (W)	Lumens (lm)	REF	PVP
45	Cromo brillo y metacrilato	4000	8	890	LAC.45.B	-
60	Cromo brillo y metacrilato	4000	12	1295	LAC.60.B	-

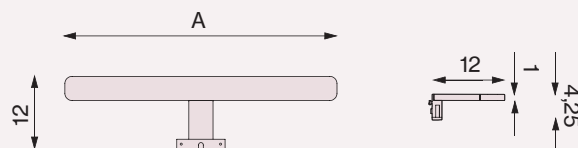

### LEDBAR



Compatible con el modelo SLM

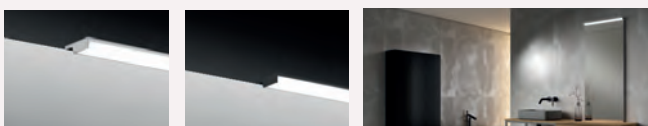

LUZ

LED

COLOR °K

4000°K  
Neutra

CONSUMO

4.9W  
8W

POTENCIA

960  
LUMENS  
metro lineal

ESTANQUEIDAD

IP20

A (cm)	Color	Temp (°K)	Consumo(W)	Lumens (lm)	REF	PVP
60	Cromo	4000	15	1365	LAB.60.B	-
80	Cromo	4000	20	1870	LAB.80.B	-
100	Cromo	4000	25	2355	LAB.10.B	-
120	Cromo	4000	30	2780	LAB.12.B	-
140	Cromo	4000	35	3320	LAB.14.B	-

60	Negro	4000	15	1365	LAB.60.N	-
80	Negro	4000	20	1870	LAB.80.N	-
100	Negro	4000	25	2355	LAB.10.N	-
120	Negro	4000	30	2780	LAB.12.N	-
140	Negro	4000	35	3320	LAB.14.N	-

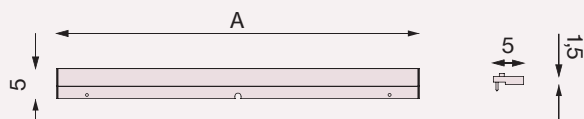

LEDARC



Colgadores de suspensión regulables



LUZ	COLOR °K	CONSUMO	POTENCIA	ESTANQUEIDAD
LED	3000°K Cálida	26W	3500 LUMENS metro lineal	IP20

A (cm)	Color	Temp (°K)	Consumo(W)	Lumens (lm)	REF	PVP
120	Negro	3000	26	3500	LCA.12.N	-

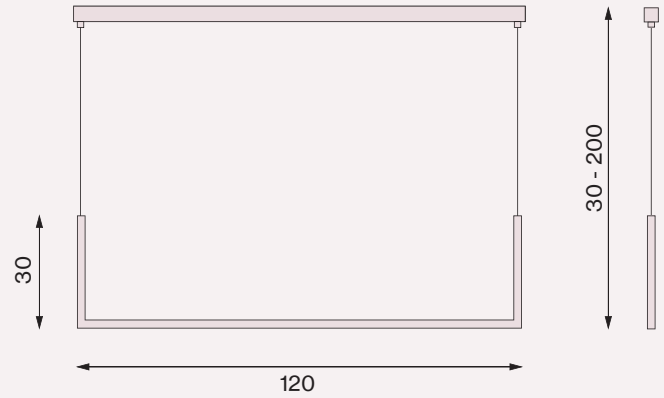

LEDPOINT



Colgadores de suspensión regulables

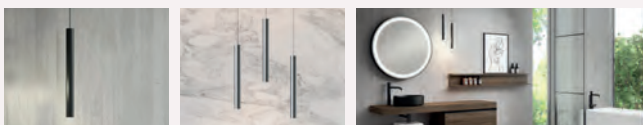

LUZ	COLOR °K	CONSUMO	POTENCIA	ESTANQUEIDAD
LED	3000°K Cálida 4000°K Neutra	6W	760 LUMENS metro lineal	IP20

Color	Temp (°K)	Consumo (W)	Lumens (lm)	REF	PVP
Blanco	3000	6	760	LCP.30W	-
Blanco	4000	6	760	LCP.40W	-
Negro	3000	6	760	LCP.30.N	-
Negro	4000	6	760	LCP.40.N	-
Cobre	3000	6	760	LCP.30.CU	-
Cobre	4000	6	760	LCP.40.CU	-
Oro	3000	6	760	LCP.30.AU	-
Oro	4000	6	760	LCP.40.AU	-
Acero	3000	6	760	LCP.30.S	-
Acero	4000	6	760	LCP.40.S	-

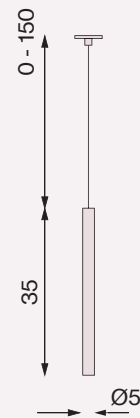



LEDCIRC



Colgadores de suspensión regulables

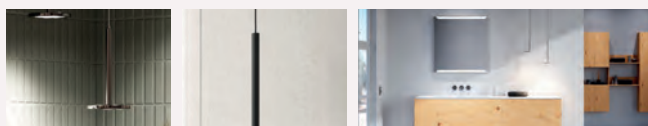

LUZ	COLOR °K	CONSUMO	POTENCIA	ESTANQUEIDAD
LED	3000°K Cálida 4000°K Neutra	6W	660 LUMENS metro lineal	IP20

Color	Temp (°K)	Consumo (W)	Lumens (lm)	REF	PVP
Blanco	3000	6	660	LCC.30.W	-
Negro	3000	6	660	LCC.30.N	-
Cobre	3000	6	660	LCC.30.CU	-
Oro	3000	6	660	LCC.30.AU	-
Acero	3000	6	660	LCC.30.S	-

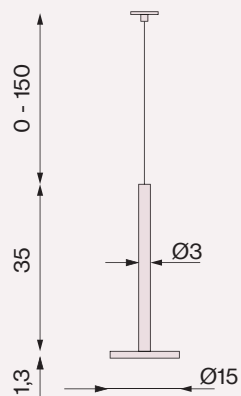



# 06

## Auxiliares

La decoración del baño es un conjunto.  
Columnas, armarios, estantes, bañeras  
o accesorios suman en una  
propuesta integral.

**COLUMNAS**



**Columna suspendida H160 puerta madera**

pág. 328



**Columna suspendida H160 vitrina**

pág. 328



**Columna suspendida H160 espejo**

pág. 329



**Columna suspendida H160 decorativa**

pág. 329

**ARMARIOS**

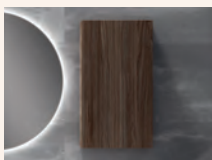

**Armario H72 puerta madera**

pág. 330

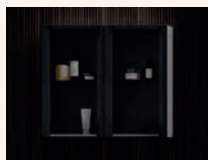

**Armario H72 vitrina**

pág. 330



**Armario H72 puerta espejo**

pág. 331



**Armario H90 decorativo**

pág. 331

**ESTANTERÍAS**



**Estantería Complet**

pág. 332

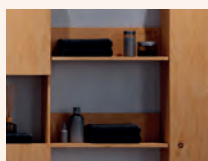

**Estantería Twin**

pág. 332



**Estantería Box**

pág. 333

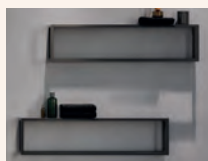

**Estantería metálica con doble estante**

pág. 333

TOALLEROS

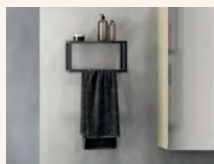

**Estantería metálica con toallero**

pág. 334

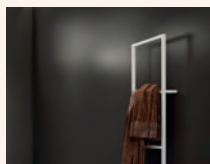

**Toallero de pared**

pág. 334



**Toallero de pie independiente**

pág. 335



**Banqueta**

pág. 335

AUXILIARES ATELIER

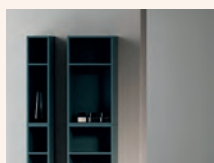

**Módulo de columna**

pág. 336

By **circulo cuadrado**



**Conjunto tocador espejo**

pág. 337

By **circulo cuadrado**

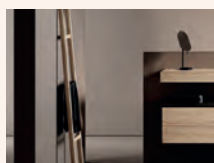

**Toallero Lean**

pág. 337



### PUSH PUERTAS SIN TIRADOR

Las puertas de las columnas y armarios tienen el sistema de expulsión Push que se puede utilizar también con función únicamente de retenedor.

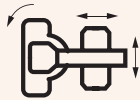

### BLUM 3D BISAGRAS

Las bisagras tienen regulación de altura, profundidad e inclinación para un ajuste perfecto.

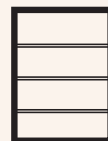

### ESTANTES INTERIORES CRISTAL

Los estantes interiores de cristal son de 6 mm de espesor. En el caso de columnas y armarios de vitrina los estantes son de color gris fumé.



### SISTEMA COLGAR SEGURIDAD ANTIDESCUELGUE 150 KG

Las columnas y armarios llevan un sistema de colgar antidescuelgue de seguridad con una capacidad de carga de 150 Kg.



### ANTRACITA FULLCOLOR

Concepto de diseño interior por el que todos los materiales del interior de los muebles están diseñados en color antracita. Los muebles con acabado lacado se lacan interiormente en color antracita.



### A MEDIDA

Esta colección permite su fabricación a medida. En el caso de medidas intermedias de altura y anchura tomar el precio de la medida inmediatamente superior.



### DECOBUILD SYSTEM

Los muebles fabricados con tableros de 19 mm están encolados entre sí con clavillas consiguiendo una estética limpia sin herrajes visibles y ofreciendo mejor resistencia y durabilidad.



### WOOD PROTECT SYSTEM

Las maderas tablero marino o madera maciza están protegidas contra los agentes externos con aceites naturales que respetan la textura y naturaleza de la madera.



### DURALACK SYSTEM

Los colores lacados llevan unos aditivos endurecedores que permiten que el acabado final sea muy resistente al frote y a la abrasión.

## Escoge color de tu mueble auxiliar

### Lacados



### Madera Tablero Marino / Chapa de Roble y Nogal

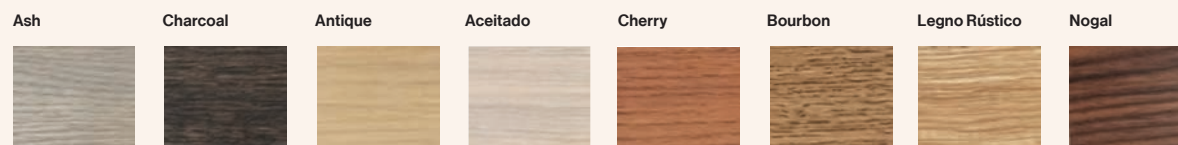

### Madera Nature

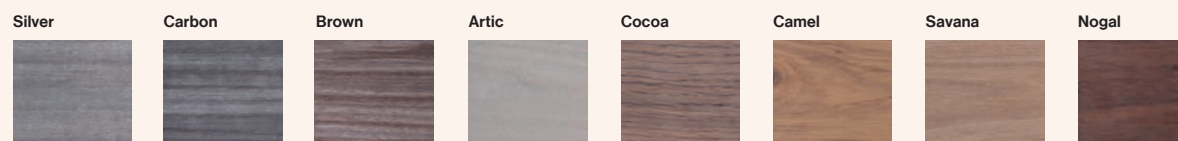

### Madera Maciza / Roble

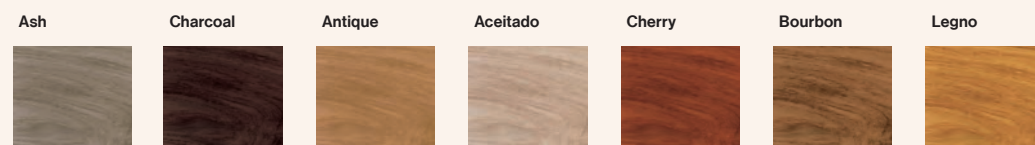

### COLUMNA SUSPENDIDA H160 MADERA

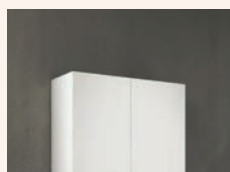

- Interior: 4 estantes de cristal/ 5 huecos
- Sistema de apertura Push
- Trasera color antracita

A (cm)	H (cm)	Apertura	REF	MADERA NATURE	LACA	MADERA TABLERO MARINO
				PVP	PVP	PVP
30	160		XCM.030I	-	-	-
30	160		XCM.030D	-	-	-
40	160		XCM.040I	-	-	-
40	160		XCM.040D	-	-	-
60	160		XCM.060X	-	-	-

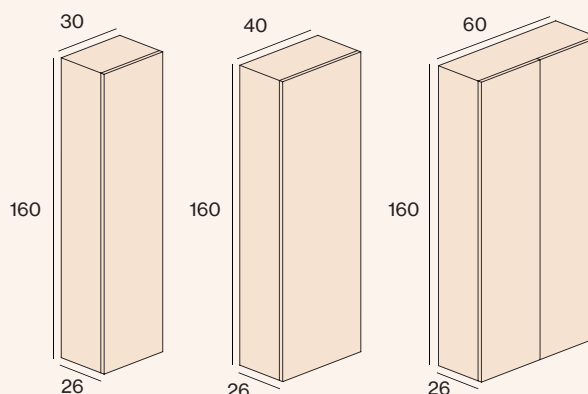

### COLUMNA SUSPENDIDA H160 VITRINA

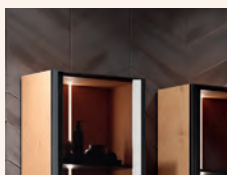

- Interior: 4 estantes de cristal/ 5 huecos
- Sistema de apertura Push
- Trasera color antracita
- Puerta enmarcada negro mate con cristal negro fumé

A (cm)	H (cm)	Apertura	REF	MADERA NATURE	LACA	MADERA TABLERO MARINO
				PVP	PVP	PVP
30	160		XCV.030I	-	-	-
30	160		XCV.030D	-	-	-
40	160		XCV.040I	-	-	-
40	160		XCV.040D	-	-	-
60	160		XCV.060X	-	-	-

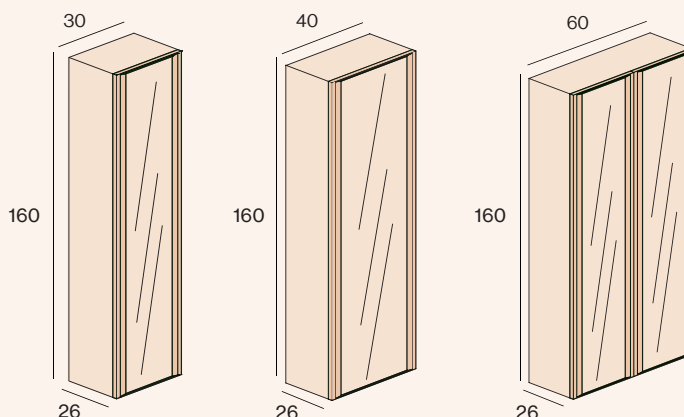

Puedes equipar tu columna con iluminación interior. Ver pág. 250



### COLUMNA SUSPENDIDA H160 ESPEJO

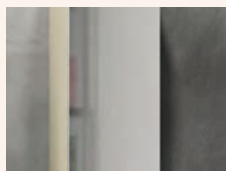

- Interior: 4 estantes de cristal / 5 huecos
- Sistema de apertura Push
- Trasera color antracita

A (cm)	H (cm)	Apertura	REF	MADERA NATURE	LACA	MADERA TABLERO MARINO
				PVP	PVP	PVP
30	160		XCE.030I	-	-	-
30	160		XCE.030D	-	-	-
40	160		XCE.040I	-	-	-
40	160		XCE.040D	-	-	-
60	160		XCE.060X	-	-	-

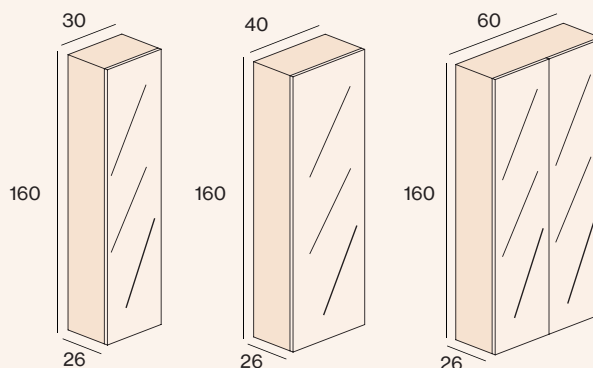

### COLUMNA SUSPENDIDA H160 DECORATIVA

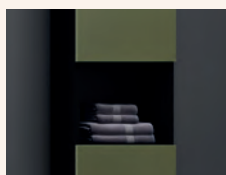

- Interior: puerta superior
- 2 estantes de cristal / 3 huecos
- Sistema de apertura Push
- Trasera color antracita

A (cm)	H (cm)	Apertura	REF	MADERA NATURE	LACA	MADERA TABLERO MARINO
				PVP	PVP	PVP
30	160		XCD.030I	-	-	-
30	160		XCD.030D	-	-	-
40	160		XCD.040I	-	-	-
40	160		XCD.040D	-	-	-
60	160		XCD.060X	-	-	-

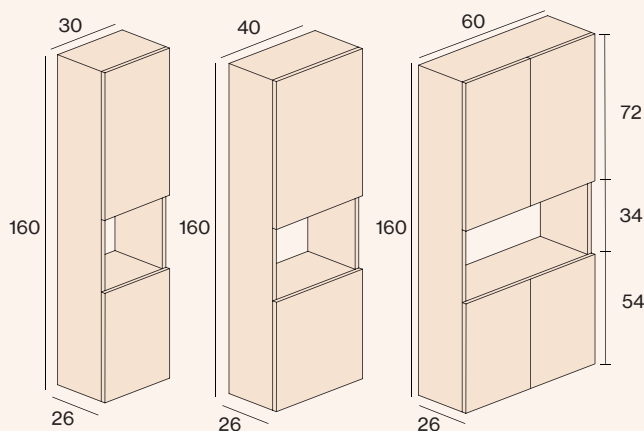

#### PATAS H7

- Juego de patas cromo brillo altura 7 cm. (4uds)

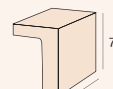

Cromo Brillo



REF	UDS	PVP
CM7	4	-

#### PATAS H3

- Juego de patas cromo brillo altura 3 cm. (4 uds)

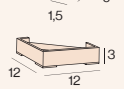

Cromo Brillo



REF	UDS	PVP
CM6	4	-

### ARMARIO H72 PUERTA MADERA

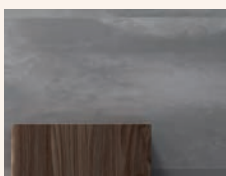

- Interior: 2 estantes de cristal/ 3 huecos
- Sistema de apertura Push
- Trasera color antracita

A (cm)	H (cm)	Apertura	REF	MADERA NATURE	LACA	MADERA TABLERO MARINO
				PVP	PVP	PVP
30	72	☐	XAM.030I	-	-	-
30	72	☐	XAM.030D	-	-	-
40	72	☐	XAM.040I	-	-	-
40	72	☐	XAM.040D	-	-	-
60	72	☐	XAM.060X	-	-	-

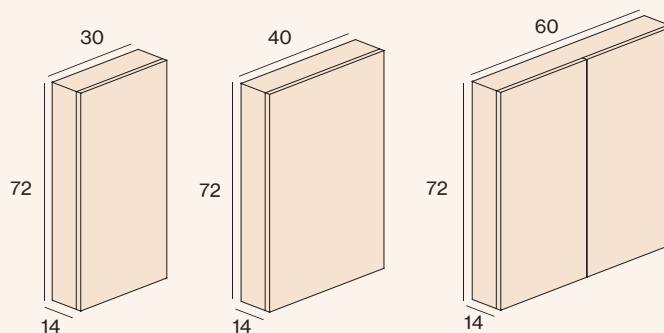

### ARMARIO H72 VITRINA

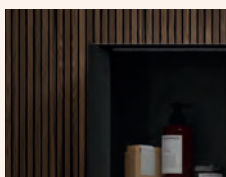
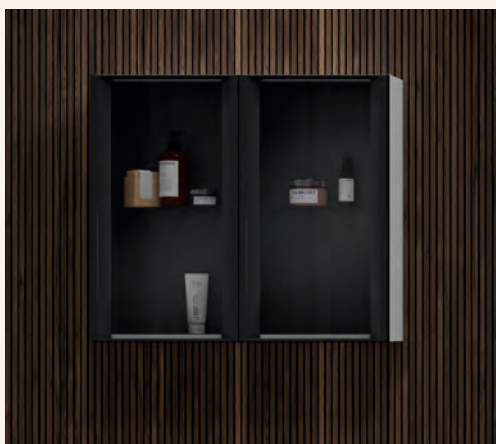

- Interior: 2 estantes de cristal/ 3 huecos
- Sistema de apertura Push
- Trasera color antracita
- Puerta enmarcada negro mate con cristal negro fumé

A (cm)	H (cm)	Apertura	REF	MADERA NATURE	LACA	MADERA TABLERO MARINO
				PVP	PVP	PVP
30	72	☐	XAV.030I	-	-	-
30	72	☐	XAV.030D	-	-	-
40	72	☐	XAV.040I	-	-	-
40	72	☐	XAV.040D	-	-	-
60	72	☐	XAV.060X	-	-	-

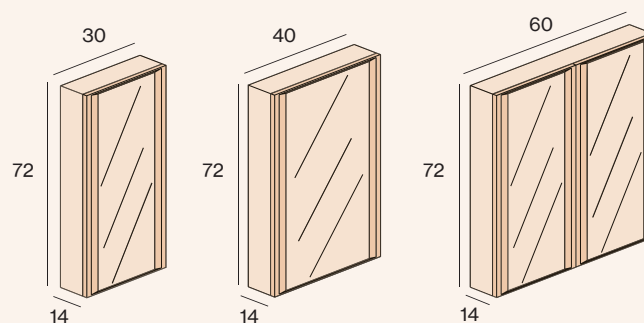

### ARMARIO H72 PUERTA ESPEJO

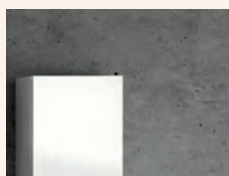
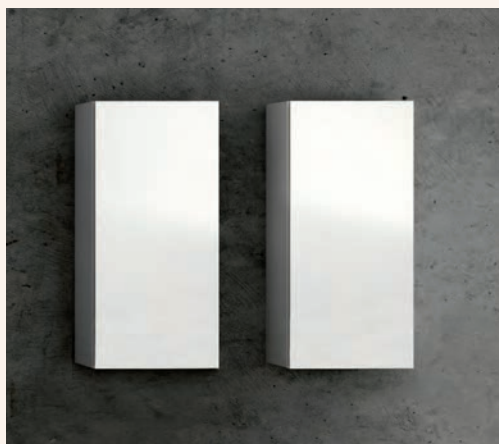

- Interior: 2 estantes de cristal/ 3 huecos
- Sistema de apertura Push
- Trasera color antracita

A (cm)	H (cm)	Apertura	REF	MADERA NATURE	LACA	MADERA TABLERO MARINO
				PVP	PVP	PVP
30	72		XAE.030I	-	-	-
30	72		XAE.030D	-	-	-
40	72		XAE.040I	-	-	-
40	72		XAE.040D	-	-	-
60	72		XAE.060X	-	-	-

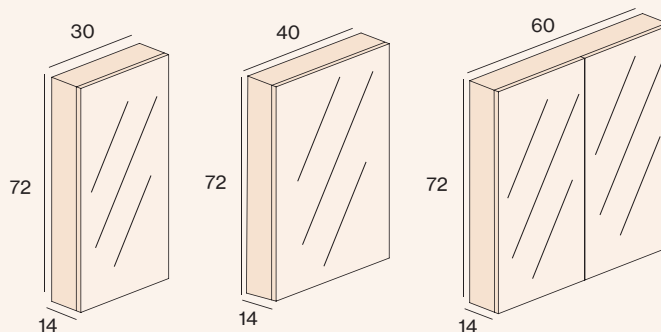

### ARMARIO H90 DECORATIVO



- Interior: 2 estantes de cristal/ 3 huecos
- Sistema de apertura Push
- Trasera color antracita

A (cm)	H (cm)	Apertura	REF	MADERA NATURE	LACA	MADERA TABLERO MARINO
				PVP	PVP	PVP
30	90		XAD.030I	-	-	-
30	90		XAD.030D	-	-	-
40	90		XAD.040I	-	-	-
40	90		XAD.040D	-	-	-
60	90		XAD.060X	-	-	-

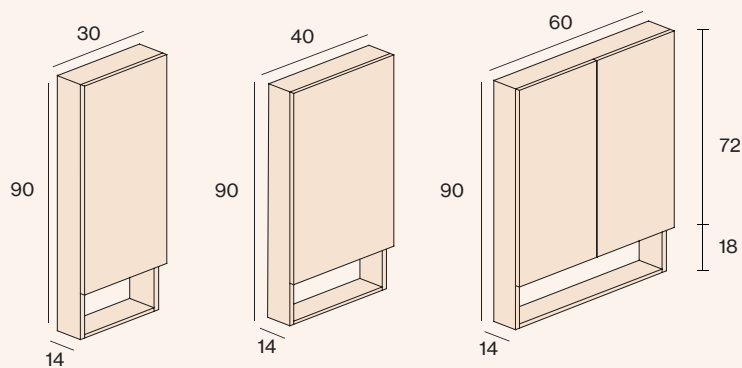

### ESTANTERÍA COMPLET

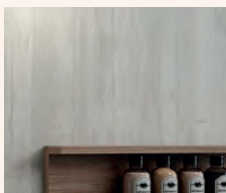

A (cm)	REF	MADERA NATURE	LACA	MADERA TABLERO MARINO	MADERA MACIZA
		PVP	PVP	PVP	PVP
30	XEC.030	-	-	-	-
40	XEC.040	-	-	-	-
60	XEC.060	-	-	-	-
70	XEC.070	-	-	-	-
80	XEC.080	-	-	-	-
90	XEC.090	-	-	-	-
100	XEC.100	-	-	-	-
120	XEC.120	-	-	-	-
140	XEC.140	-	-	-	-

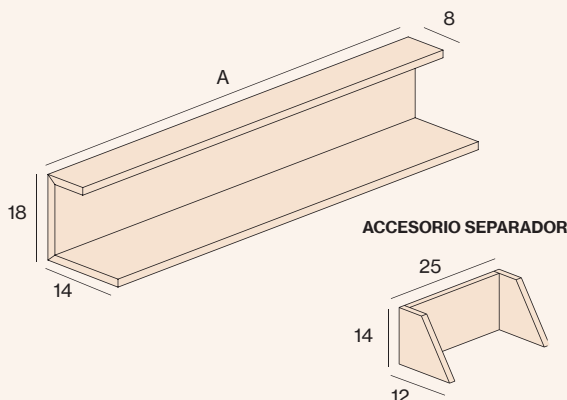

REF	PVP
XSD.2501	-

**Lacado**

### ESTANTERÍA TWIN

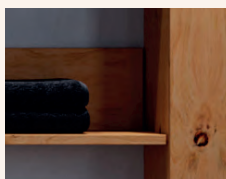

A (cm)	REF	MADERA NATURE	LACA	MADERA TABLERO MARINO	MADERA MACIZA
		PVP	PVP	PVP	PVP
30	XEL.030	-	-	-	-
40	XEL.040	-	-	-	-
60	XEL.060	-	-	-	-
70	XEL.070	-	-	-	-
80	XEL.080	-	-	-	-
90	XEL.090	-	-	-	-
100	XEL.100	-	-	-	-
120	XEL.120	-	-	-	-
140	XEL.140	-	-	-	-

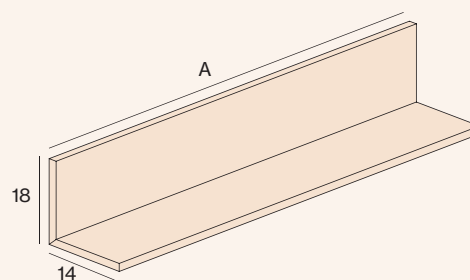

## ESTANTERÍA BOX



A (cm)	REF	MADERA NATURE	LACA	MADERA TABLERO MARINO	MADERA MACIZA
		PVP	PVP	PVP	PVP
30	XEB.030	-	-	-	-
40	XEB.040	-	-	-	-
60	XEB.060	-	-	-	-
70	XEB.070	-	-	-	-
80	XEB.080	-	-	-	-
90	XEB.090	-	-	-	-
100	XEB.100	-	-	-	-
120	XEB.120	-	-	-	-
140	XEB.140	-	-	-	-

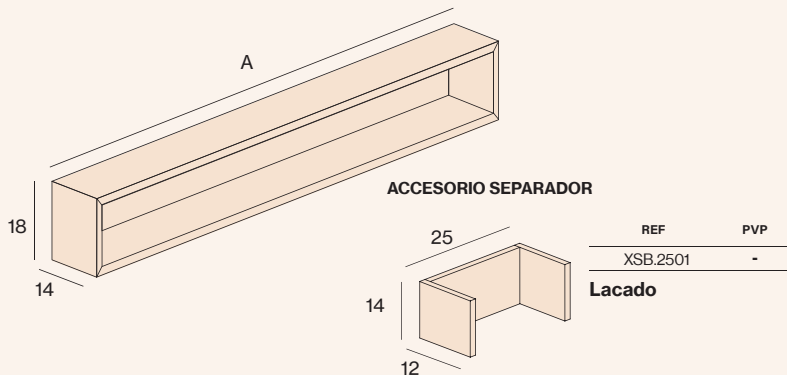

## ESTANTERÍA METÁLICA CON DOBLE ESTANTE

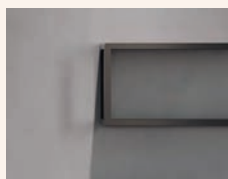

A (cm)	REF	MADERA NATURE	LACA	MADERA TABLERO MARINO	MADERA MACIZA	CRISTAL FUMÉ
		PVP	PVP	PVP	PVP	PVP
<b>ESTRUCTURA METÁLICA NEGRA</b>						
30	XEM.030.N	-	-	-	-	-
40	XEM.040.N	-	-	-	-	-
60	XEM.060.N	-	-	-	-	-
70	XEM.070.N	-	-	-	-	-
80	XEM.080.N	-	-	-	-	-
90	XEM.090.N	-	-	-	-	-
100	XEM.100.N	-	-	-	-	-
120	XEM.120.N	-	-	-	-	-
140	XEM.140.N	-	-	-	-	-

<b>ESTRUCTURA METÁLICA COLOR (CARTA LACADOS)</b>						
30	XEM.030.C	-	-	-	-	-
40	XEM.040.C	-	-	-	-	-
60	XEM.060.C	-	-	-	-	-
70	XEM.070.C	-	-	-	-	-
80	XEM.080.C	-	-	-	-	-
90	XEM.090.C	-	-	-	-	-
100	XEM.100.C	-	-	-	-	-
120	XEM.120.C	-	-	-	-	-
140	XEM.140.C	-	-	-	-	-

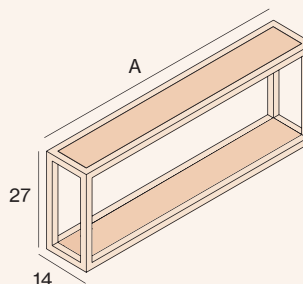

ESTANTERÍA METÁLICA CON TOALLERO



A (cm)	REF	MADERA NATURE	LACA	MADERA TABLERO MARINO	MADERA MACIZA	CRISTAL FUMÉ
		PVP	PVP	PVP	PVP	PVP

ESTRUCTURA METÁLICA NEGRA

30	XET.030.N	-	-	-	-	-
40	XET.040.N	-	-	-	-	-
60	XET.060.N	-	-	-	-	-
70	XET.070.N	-	-	-	-	-
80	XET.080.N	-	-	-	-	-
90	XET.090.N	-	-	-	-	-
100	XET.100.N	-	-	-	-	-
120	XET.120.N	-	-	-	-	-
140	XET.140.N	-	-	-	-	-

ESTRUCTURA METÁLICA COLOR (CARTA LACADOS)

30	XET.030.C	-	-	-	-	-
40	XET.040.C	-	-	-	-	-
60	XET.060.C	-	-	-	-	-
70	XET.070.C	-	-	-	-	-
80	XET.080.C	-	-	-	-	-
90	XET.090.C	-	-	-	-	-
100	XET.100.C	-	-	-	-	-
120	XET.120.C	-	-	-	-	-
140	XET.140.C	-	-	-	-	-

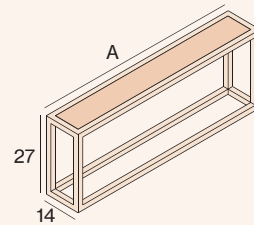

TOALLERO DE PARED

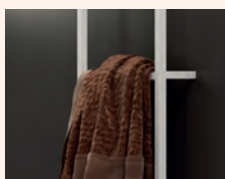

REF	PVP
-----	-----

ESTRUCTURA METÁLICA NEGRA

XTP:160.N	-
-----------	---

ESTRUCTURA METÁLICA COLOR (CARTA LACADOS)

XTP:160.C	-
-----------	---

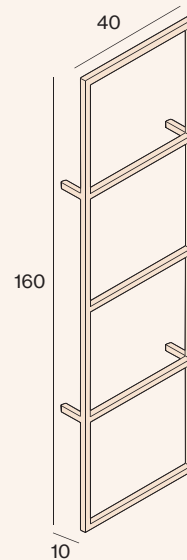

TOALLERO DE PIE INDEPENDIENTE

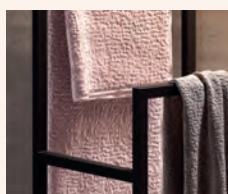

REF	PVP
<b>ESTRUCTURA METÁLICA NEGRA</b>	
XTI.090.N	-
<b>ESTRUCTURA METÁLICA COLOR (CARTA LACADOS)</b>	
XTI.090.C	-

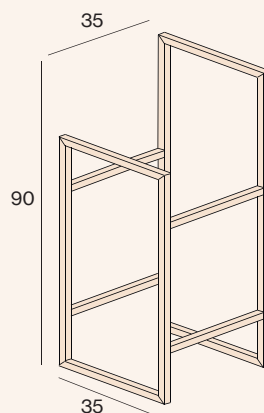

BANQUETA



A (cm)	REF	MADERA NATURE	LACA	MADERA TABLERO MARINO	MADERA MACIZA
		PVP	PVP	PVP	PVP
<b>ESTRUCTURA METÁLICA NEGRA</b>					
35	XTU.035.N	-	-	-	-
60	XTU.060.N	-	-	-	-
<b>ESTRUCTURA METÁLICA COLOR (CARTA LACADOS)</b>					
35	XTU.035.C	-	-	-	-
60	XTU.060.C	-	-	-	-

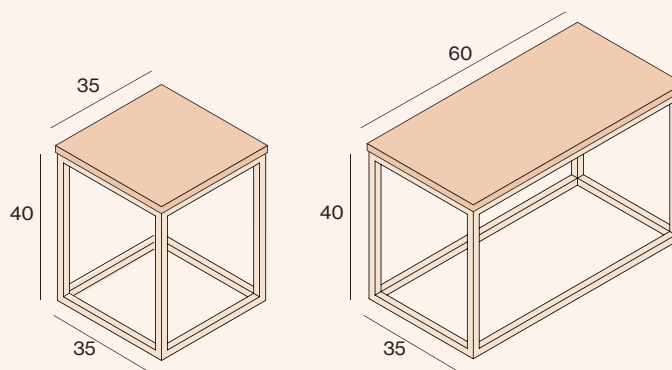

### MÓDULO DE COLUMNA

By **CÍRCULO CUADRADO**



A (cm)	H (cm)	REF	LACA
			<b>PVP</b>
30	60	XMD.3060	-
15	60	XMD.1560	-
30	90	XMD.3090	-
15	90	XMD.1590	-
30	180	XMD.30180	-
15	180	XMD.15180	-

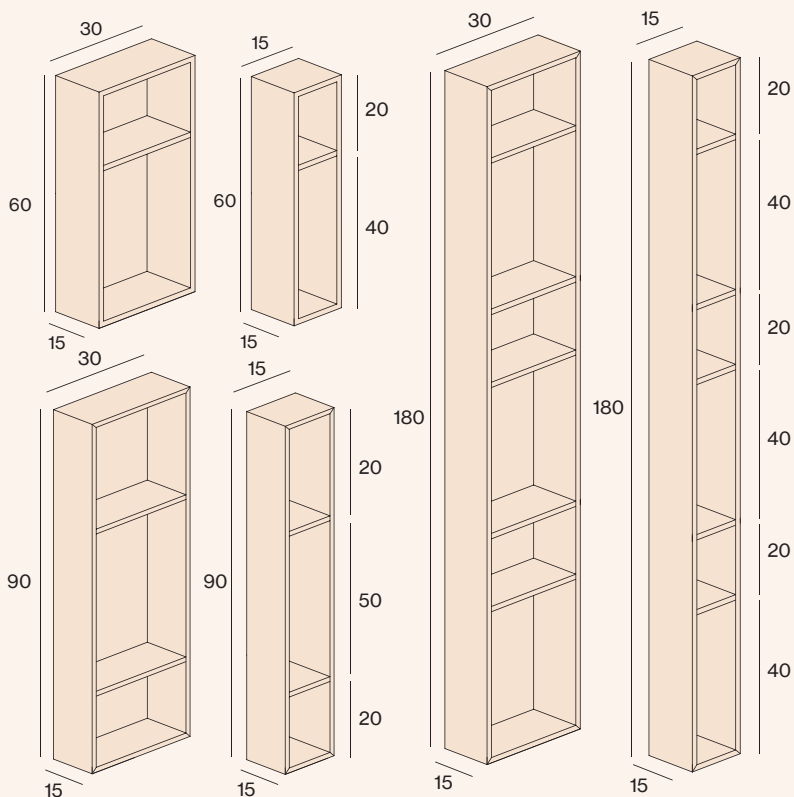

- Grosor 13 mm
- Sistema de colgar oculto
- Instalación en 2 posiciones

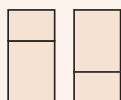



### CONJUNTO TOCADOR ESPEJO

By **CÍRCULO CUADRADO**



- Grosor 13 mm
- Sistema de colgar oculto
- Espejo opcional

A (cm)	SIN ESPEJO		CON ESPEJO	
	REF	PVP	REF	PVP
60	XMB.60	-	XMS.60	-
90	XMB.90	-	XMS.90	-

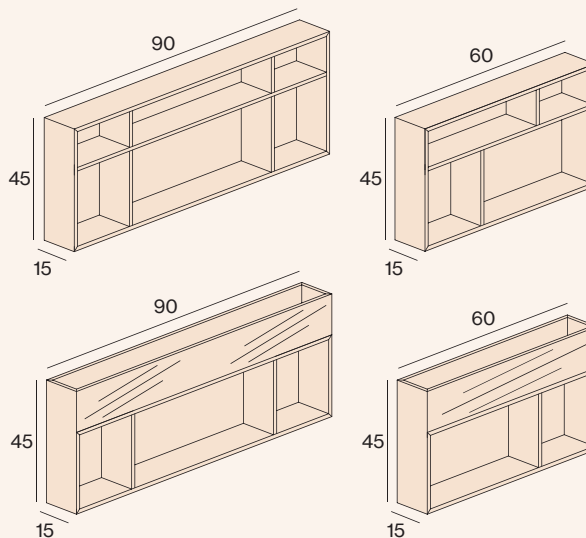

### TOALLERO LEAN

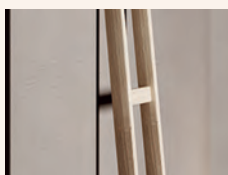

- En roble macizo de 20 mm de grosor

### REF MADERA MACIZA

REF	PVP
XML	-

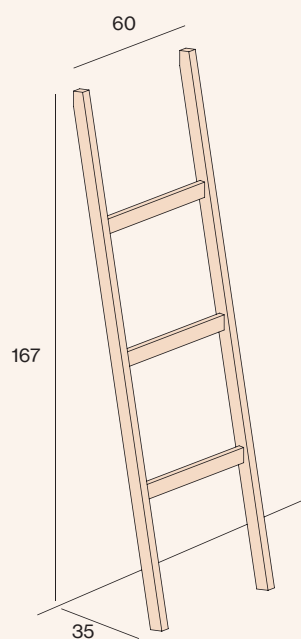

Nuevo catálogo de BAÑERAS 2023



---

consúltalo en [www.decosan.com](http://www.decosan.com)

---

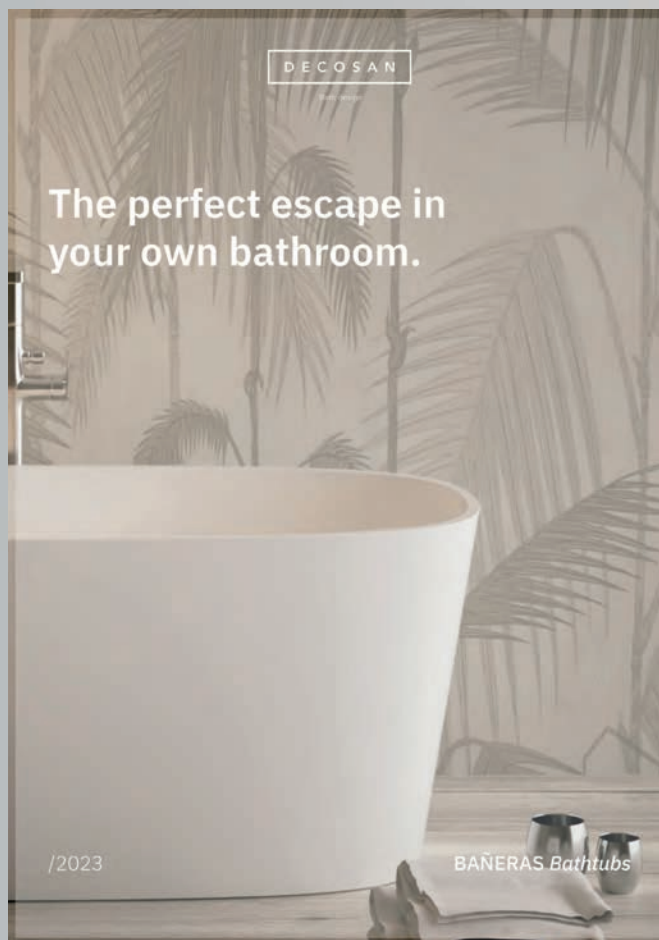

# Catálogo exclusivo COLECCIONES DE BAÑO

DECOSAN

consúltalo en [www.decosan.com](http://www.decosan.com)







# 07 Colores

Colores y acabados que transmiten emociones.

**Blanco Mate**

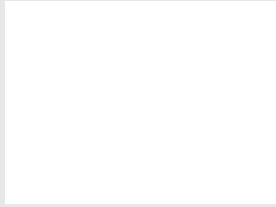

**Negro Mate**

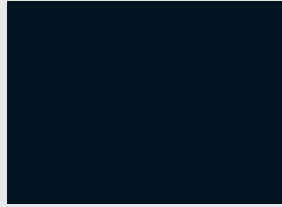

**Beige Mate**

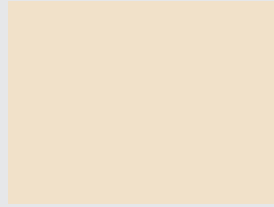

**Tierra Mate**



**Caqui Mate**

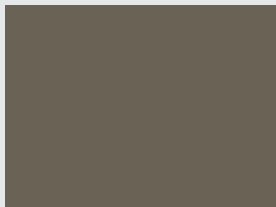

**Cuarzo Mate**



**Moka Mate**



**Perla Mate**

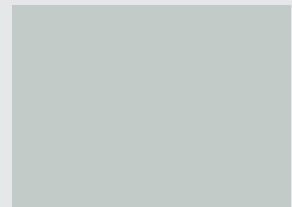

**Piedra Mate**



**Acero Mate**



**Antracita Mate**



**Burdeos Mate**



**Océano Mate**



**Menta Mate**

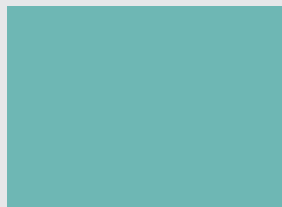

**Oliva Mate**



**Terracota Mate**

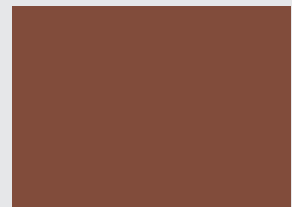

**Albero Mate**



**Rosa Mate**

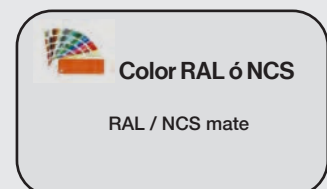
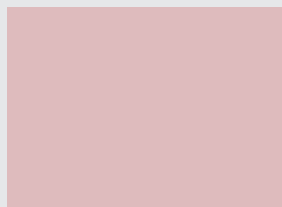

**Blanco Brillo**

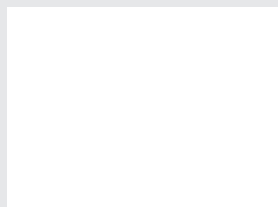

**Negro Brillo**

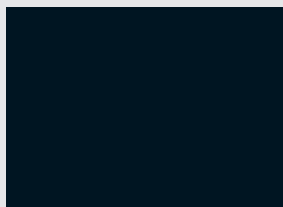

**Beige Brillo**

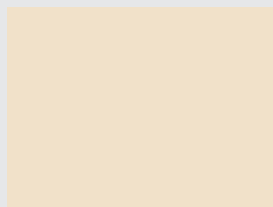

**Tierra Brillo**



**Caqui Brillo**

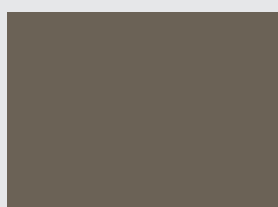

**Cuarzo Brillo**



**Moka Brillo**

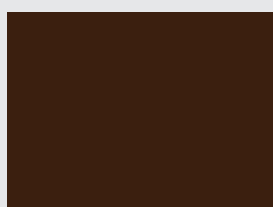

**Perla Brillo**

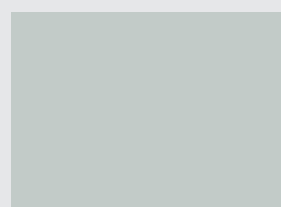

**Piedra Brillo**

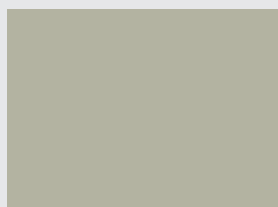

**Acero Brillo**



**Antracita Brillo**

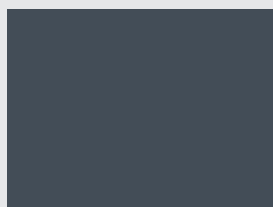

**Burdeos Brillo**



**Océano Brillo**



**Menta Brillo**

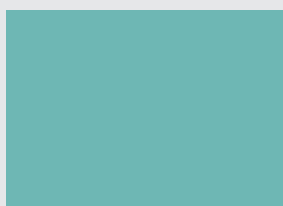

**Oliva Brillo**



**Terracota Brillo**

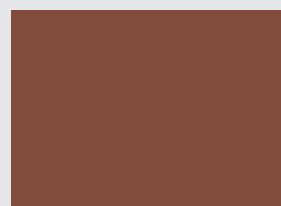

**Albero Brillo**



**Rosa Brillo**

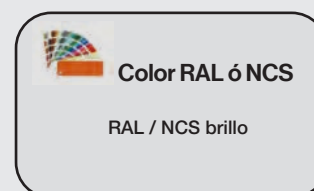
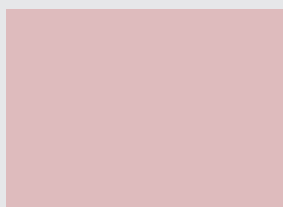

**Silver**



**Carbon**



**Brown**



**Artic**



**Cocoa**

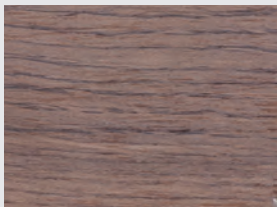

**Camel**

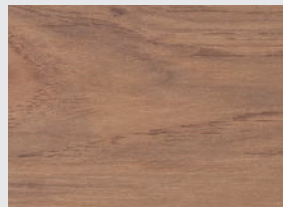

**Savana**

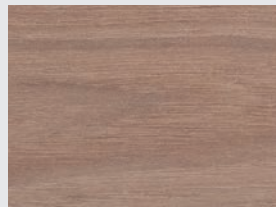

**Nogal**

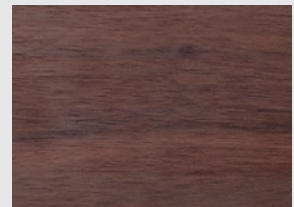

Madera Tablero Marino

**Ash**

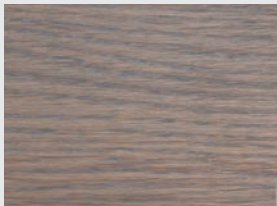

**Charcoal**

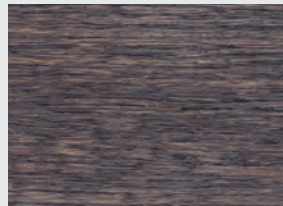

**Antique**

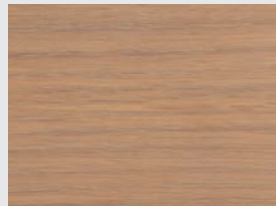

**Aceitado**

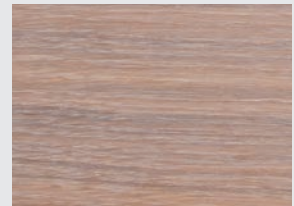

**Cherry**

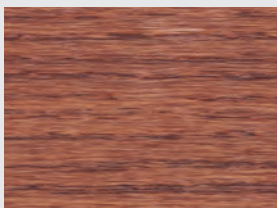

**Bourbon**



**Legno Rústico**

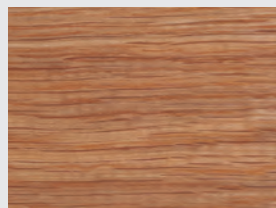

**Nogal**

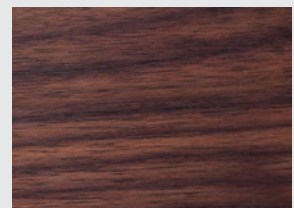



Ash



Charcoal

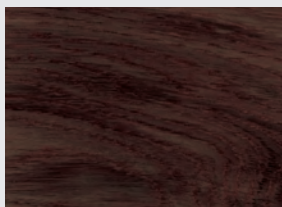

Antique



Aceitado

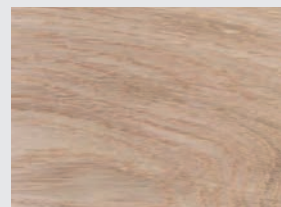

Cherry

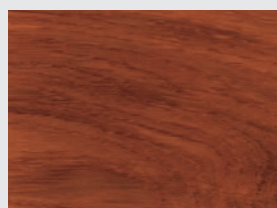

Bourbon

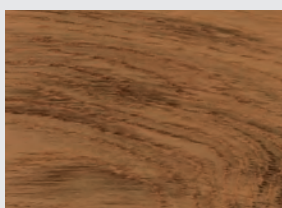

Legno



Ceramcolor

Blanco

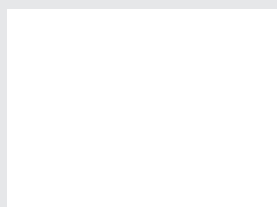

Negro

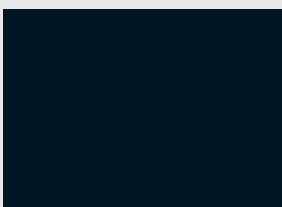

Tierra



Cuarzo



Acero



Antracita

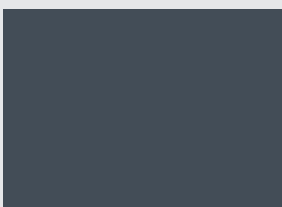

Oliva



**Blanco**

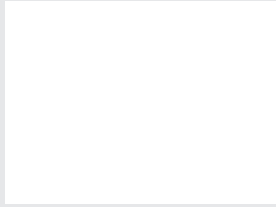

**Negro**

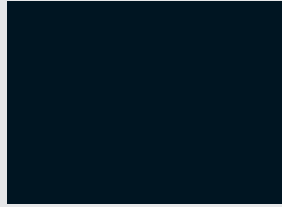

**Beige**

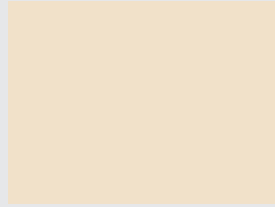

**Tierra**



**Caqui**

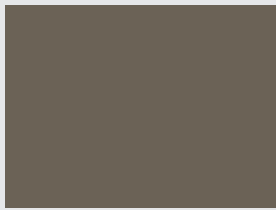

**Cuarzo**



**Moka**

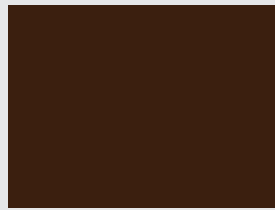

**Perla**



**Piedra**



**Aceros**



**Antracita**



**Burdeos**



**Océano**



**Menta**

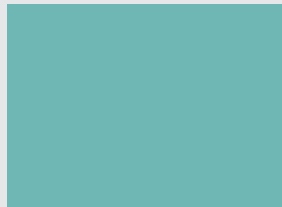

**Oliva**

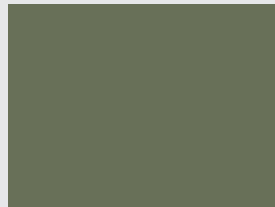

**Terracota**

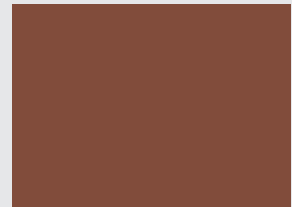

**Albero**



**Rosa**

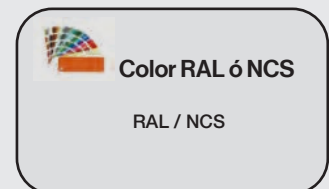
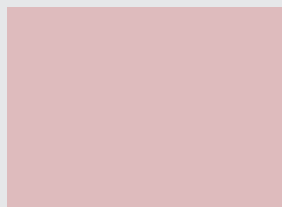

**Negro Compacto**



**Negro Marquina**



**Pietra Gris**



**Verde India**

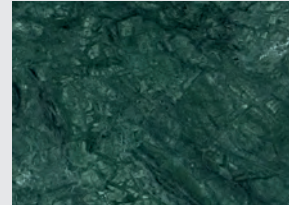

**Marrón Imperial**

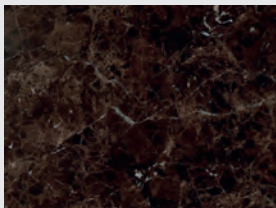

**Crema Marfil**



**Carrara**



Metal

**Oro Cepillado**

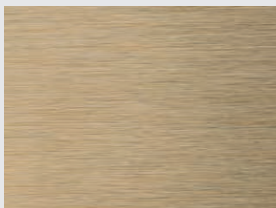

**Cobre Cepillado**

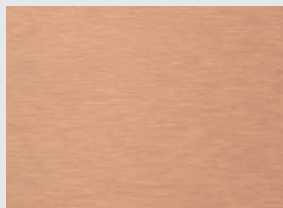

**Acero Cepillado**

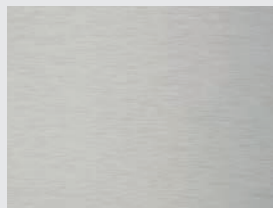

# Condiciones de venta

Las condiciones que se exponen a continuación son válidas para las ventas de productos de Artesanía Baño, S.L.-DECOSAN. La emisión de pedidos por parte de la empresa compradora implica la aceptación de las actuales condiciones de venta. Cualquier modificación de estas condiciones estará sujeta a aprobación por escrito por parte de Artesanía Baño, S.L.-DECOSAN.

## Precios

Los precios no incluyen IVA ni otros impuestos. Los precios del catálogo podrán ser modificados sin previo aviso y son válidos según tarifa vigente el día de la expedición.

## Impuestos

Cargados en factura conforme a la legislación vigente. Los compromisos de pago deberán efectuarse al contado o según las condiciones de crédito pactadas y según lo establecido en la Ley 16/2009 de 13 de noviembre, de servicios de pago.

## Condiciones de pago

Hasta la concesión de la oportuna clasificación y riesgo, todas las operaciones serán abonadas mediante pago anticipado.

## Operaciones sucesivas

El aplazamiento de pago de nuestras facturas será el acordado entre ambas partes. Transcurridos los vencimientos acordados, quedamos automáticamente autorizados a contabilizar los intereses de demora a razón de un UNO POR CIENTO por mes o fracción.

Las entregas pendientes de facturación vencerán siempre inmediatamente cuando el comprador se declare insolvente, si se interpone procedimiento de quiebra o concurso de acreedores, si se enajenase su empresa o si hubiera un cambio de propiedad.

En caso de incumplimiento de las condiciones de pago y/o devolución de los efectos negociados, Artesanía Baño, S.L.-DECOSAN repercutirá íntegramente los gastos de devolución y los gastos de administración dando por canceladas (por incumplimiento) las condiciones pactadas con el cliente y dando por vencidos los efectos pendientes.

Reserva de dominio

La mercancía se considera propiedad de Artesanía Baño, S.L. / DECOSAN hasta el total pago de la misma por el cliente, teniendo Artesanía Baño, S.L. / DECOSAN hasta ese momento reserva de dominio.

## Jurisdicción

La presente relación se regirá por la legislación española. En caso de cualquier litigio, las partes renuncian expresamente a cualquier otro foro o jurisdicción a los que pudiesen tener derecho y acuerdan someterse a los tribunales de Barcelona.

## Pedidos

Todos los pedidos deben formalizarse mediante documento escrito. Imprescindible para la fabricación especial:

-Adjuntar croquis con las medidas del producto solicitado.

-Abonar el 50% del importe en el momento de aceptación del pedido. El resto se abonará según las condiciones pactadas.

-Los precios no incluyen la instalación ni su puesta en marcha.

## Garantía

Se certifica que todos los productos están garantizados durante dos años por defecto de fabricación en condiciones normales de uso e instalación, según Real Decreto Legislativo 1/2007 de 16 de noviembre, comprometiéndose la empresa a reparar o reponer los materiales cuya anomalía obedezca a estas causas.

Queda excluido el derecho de indemnización por daños y perjuicios (sea cual fuese el acto fundamental legal aceptado) a menos que se demuestre fehacientemente que hubiésemos respondido con premeditación o negligencia grave. La garantía no ampara los defectos producidos por mal uso, instalación deficiente o indebida, o en su defecto los producidos por causas de fuerza mayor.

## Diseño

Artesanía Baño, S.L.-DECOSAN se reserva el derecho de realizar sin previo aviso cualquier modificación de artículos en cualquier ámbito tanto de características técnicas, estéticas o de valoración.

## Plazo de entrega

El plazo de entrega aproximado es de 3 semanas para los artículos standard de catálogo y de 4 semanas para los que estén sujetos a cualquier modificación que tendrán carácter de especial a no ser que se especifique otro plazo de suministro por razones de fabricación o planificación.

Cualquier retraso en los plazos de suministro convenidos no conlleva derecho de indemnización alguna por daños y perjuicios u otras causas.

## Transporte de la mercancía

- Cuando la mercancía viaje a porte debido, Artesanía Baño, S.L. / DECOSAN queda exonerado de las posibles taras o defectos que pudieran ser imputables al transporte de la mercancía.

- Cuando la mercancía viaje a porte pagado, el cliente tiene que notificarle a Artesanía Baño, S.L. / DECOSAN por escrito dentro de las 24 horas siguientes a la recepción de la mercancía, cualquier defecto o tara imputable a la agencia de transportes para facilitar la reclamación de la responsabilidad de acuerdo a la Ley 16/1987 de Ordenación de los Transportes terrestres y RD 1.111/1990 por el que se aprueba el reglamento de la LOTT.

- La reclamación contra el porteador por daño o avería, deberá hacerse en el acto del recibo de los bultos siempre que se trate de daños aparentes y dentro de las 24 horas siguientes al recibo, si los daños fuesen no aparentes, la protesta o reserva debe hacerse por escrito.

- Las mercancías viajan siempre por cuenta y riesgo del comprador, aún en los casos de convenios especiales.

- Portes pagados:

a Península a partir de 250 €.

a Baleares a partir de 500 €.

a Canarias a partir de 1.500 €.

a Ceuta y Melilla, portes consultar.

El precio de los portes es de 15 €. En el caso de expedición individual de cimeras, espejos o lavabos que requieran embalaje especial el porte mínimo será de 30 € netos.

## Devoluciones

Se aceptarán devoluciones sólo y exclusivamente para mercancías defectuosas y/o enviadas erróneamente por Artesanía Baño, S.L. / DECOSAN.

Cualquier devolución deberá ser siempre comunicada por escrito y autorizada por Artesanía Baño, S.L. / DECOSAN

La devolución de la mercancía deberá realizarse en el embalaje original y en perfecto estado y sufrirá una depreciación automática mínima de 15% sobre el importe facturado en concepto de gastos de gestión y almacenaje, pudiendo ésta ser mayor después de peritación.

## Roturas

Es obligación del receptor revisar el embalaje y el producto a su recepción.

En el caso de observar alguna incidencia en el momento de la descarga anotar la incidencia en el albarán y enviar una comunicación por escrito a Artesanía Baño, S.L. / DECOSAN acompañado de unas fotografías.

En el caso de no detectar ningún desperfecto visible en el momento de la descarga anotar en el albarán "conforme salvo examen" y realizar esta verificación en el plazo máximo de 24h procediendo si conviene al envío de la reclamación en las mismas condiciones escritas y con imágenes que permitan valorar la incidencia. De no seguir los trámites correspondientes, la empresa no atenderá ninguna reclamación al respecto puesto que la cobertura del transporte declina cualquier responsabilidad según la Ley 16/1987 de Ordenación de los Transportes terrestres y RD 1.111/1990 por el que se aprueba el reglamento de la LOTT.

## Confidencialidad y protección de datos

En cumplimiento de lo dispuesto en la Ley Orgánica 15/1999 de 13 de diciembre de Protección de Datos de carácter personal y al REGLAMENTO (UE) 2016/679 DEL PARLAMENTO EUROPEO Y DEL CONSEJO de 27 de abril de 2016 (GDPR), los datos de carácter personal facilitados por el comprador formarán parte del fichero del vendedor, cuyos fines son el mantenimiento de la relación contractual, gestión de ventas y cobros. El vendedor tratará estos datos con máxima confidencialidad y se compromete a no usarlos con un fin distinto a aquel para el que han sido recabados, así como a conservados con las medidas que garanticen su seguridad a terceros no autorizados. El comprador tiene derecho de acceso, rectificación y cancelación enviando una comunicación por escrito a Artesanía Baño, S.L. / DECOSAN Ctra. Laureà Miró, 385-387 - 08980 Sant Feliu de Llobregat, Barcelona o bien por correo electrónico a rgpd@nofer.com.

## Cotas recomendadas de instalación sanitaria

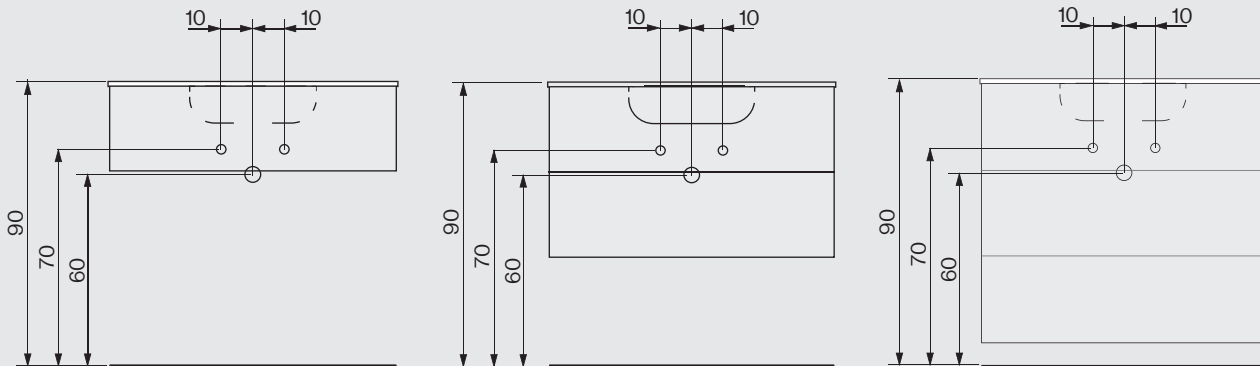

Los muebles de altura 27 y 35 cm no admiten Decospace System

## Decospace System

**Con encimera integrada**

**Con lavabo sobreencimera**

**Con registro sanitario**

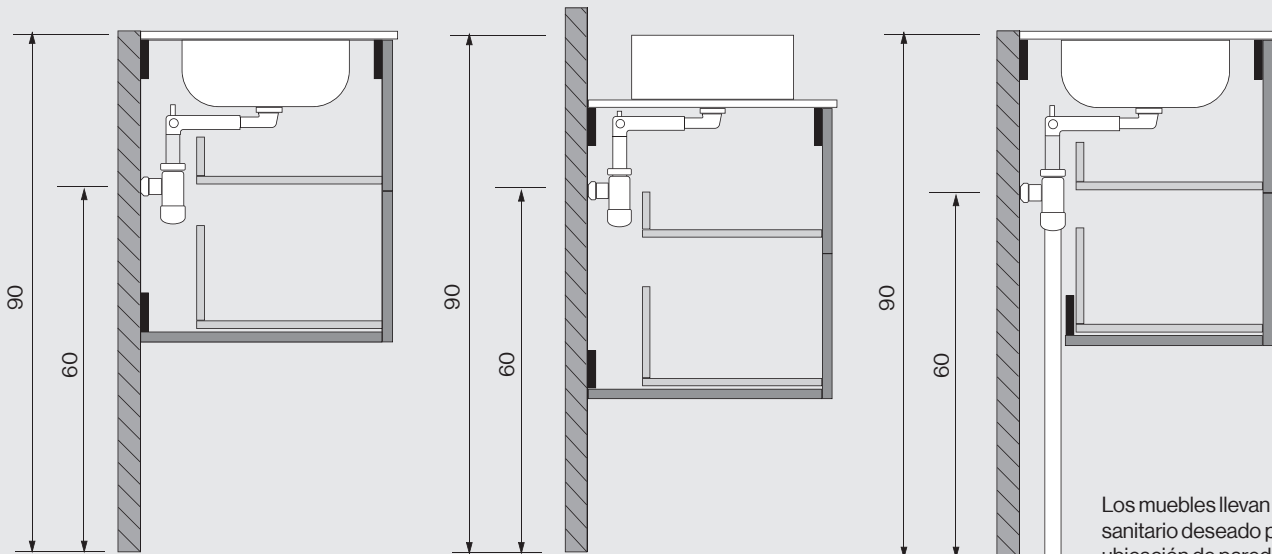

Los muebles llevan registro sanitario deseado para la ubicación de pared o suelo.

Todos los artículos suministrados con la tornillería y anclajes necesarios para su ubicación así como un manual de montaje para su correcta puesta en servicio.

DECOSAN

Bath design



# DECOSAN

## DECOSAN CENTRAL

Ctra. Laureà Miró, 385-387  
08980 Sant Feliu de Llobregat  
Barcelona – España  
tels. +34 933 378 616, +34 933 378 187  
decosan@decosan.com  
www.decosan.com

## DECOSAN BARCELONA

Showroom Contract. Rambla Catalunya, 43  
Principal, 1ª - 08007 Barcelona - España  
+34 640 04 47 45  
info@wecontractbcn.com

## DECOSAN MILANO

Via Torino, 10 – 20060 Liscate  
Milano – Italia  
+39 0249796141  
cmarconi-bocchi@nofer.com

## DECOSAN MOSCÚ

107113, Moscow - Shumkina str. 26a str.4 Russian  
Federation  
+7 (495) 602-05-85  
info@nofer-aporici.ru

## DECOSAN DUBAI

Office # 1, Industrial Area 18, Maliha Road, P.O. Box  
4316, Sharjah, UAE  
+971 65467420  
info@mena-gate.com



NOFER



DECOSAN

BOCCHI SafeWORK

agetar, s.a.



CAT.D23SP.ES